

44 W 12 V SMPS demo board with ICE5AR0680AG

DEMO_5AR0680AG_44W1

About this document

Scope and purpose

This document is an engineering report that describes a universal-input 44 W 12 V off-line flyback converter using the latest fifth-generation Infineon Fixed Frequency (FF) CoolSET™ ICE5AR0680AG, which offers high-efficiency, low-standby power with selectable entry and exit standby power options, wide VCC operating range with fast start-up, robust line protection with input Over Voltage Protection (OVP), and various modes of protection for a highly reliable system. This demonstrator board is designed for users who wish to evaluate the performance of ICE5AR0680AG in terms of optimized efficiency, thermal performance and EMI.

Intended audience

This document is intended for power-supply design/application engineers, students, etc. who wish to design low-cost, highly reliable systems of off-line SMPS, such as auxiliary power supplies for white goods, PCs, servers and TVs, or enclosed adapters for Blu-ray players, set-top boxes, games consoles, etc.

Table of contents

About this document	1
Table of contents.....	1
1 Abstract	3
2 Demo board.....	4
3 Specifications of the demo board	5
4 Circuit description.....	6
4.1 Line input.....	6
4.2 Start-up.....	6
4.3 Integrated CoolMOS™ with frequency-reduction controller	6
4.4 Frequency jittering	7
4.5 RCD clamper circuit.....	7
4.6 Output stage.....	7
4.7 FB loop.....	7
4.8 Active Burst Mode (ABM)	8
5 Protection features	9
6 Circuit diagram	10
7 PCB layout	11
7.1 Top side	11
7.2 Bottom side	11
8 Bill of Materials (BOM)	12
9 Transformer construction	14
10 350 V _{AC} operating voltage	15
10.1 Line over voltage protection at 370 V _{AC} (Non switch Auto Restart)	15
10.2 Drain and current sense voltage at 350 V _{AC} and maximum load	15

Abstract

11	Test results	16
11.1	Efficiency, regulation and output ripple.....	16
11.2	Standby power	17
11.3	Line regulation	17
11.4	Load regulation	18
11.5	Maximum input power	18
11.6	ESD immunity (EN 61000-4-2)	18
11.7	Surge immunity (EN 61000-4-5)	18
11.8	Conducted emissions (EN 55022 class B)	18
11.9	Thermal measurement	21
12	Waveforms and scope plots.....	22
12.1	Start-up at low/high AC-line input voltage with maximum load.....	22
12.2	Soft-start.....	22
12.3	Drain and CS voltage at maximum load	23
12.4	Frequency jittering	23
12.5	Load transient response (dynamic load from 10% to 100%)	24
12.6	Output ripple voltage at maximum load	24
12.7	Output ripple voltage at ABM 1 W load.....	25
12.8	Entering ABM	25
12.9	During ABM	26
12.10	Leaving ABM	26
12.11	LOV protection (non-switch auto restart)	27
12.12	V _{CC} OVP (odd-skip auto restart)	27
12.13	V _{CC} UVP (auto restart)	28
12.14	Over-load protection (odd-skip auto restart)	28
12.15	V _{CC} short-to-GND protection	29
13	References.....	30
	Revision history.....	31

Abstract

1 Abstract

This document is an engineering report for a 44 W 12 V demo board designed in an FF flyback converter topology using the fifth-generation FF CoolSET™ ICE5AR0680AG. The demo board is operated in Continuous Conduction Mode (CCM) and is running at 100 kHz fixed switching frequency to optimize low-line full-load efficiency. The frequency reduction with soft gate driving and frequency jittering offers lower EMI and better efficiency between light load and 50% load. The selectable Active Burst Mode (ABM) power enables ultra-low power consumption. In addition, numerous adjustable protection functions have been implemented in ICE5AR0680AG to protect the system and customize the IC for the chosen application. In case of failure modes such as Line Over Voltage (LOV), VCC OV/UV, open control-loop or over-load, over-temperature, VCC short-to-GND and Current Sense (CS) short-to-GND, the device enters protection mode. By means of the cycle-by-cycle Peak Current Limitation (PCL), the dimensions of the transformer and the current rating of the secondary diode can both be optimized. Thus, a cost-effective solution can easily be achieved. The target applications of ICE5AR0680AG are either auxiliary power supplies for white goods, PCs, servers and TVs, or enclosed adapters for Blu-ray players, set-top boxes, games consoles, etc.

2 Demo board

This document contains the list of features, the power-supply specifications, schematics, Bill of Materials (BOM) and the transformer construction documentation. Typical operating characteristics such as performance curve and scope waveforms are shown at the end of the report.

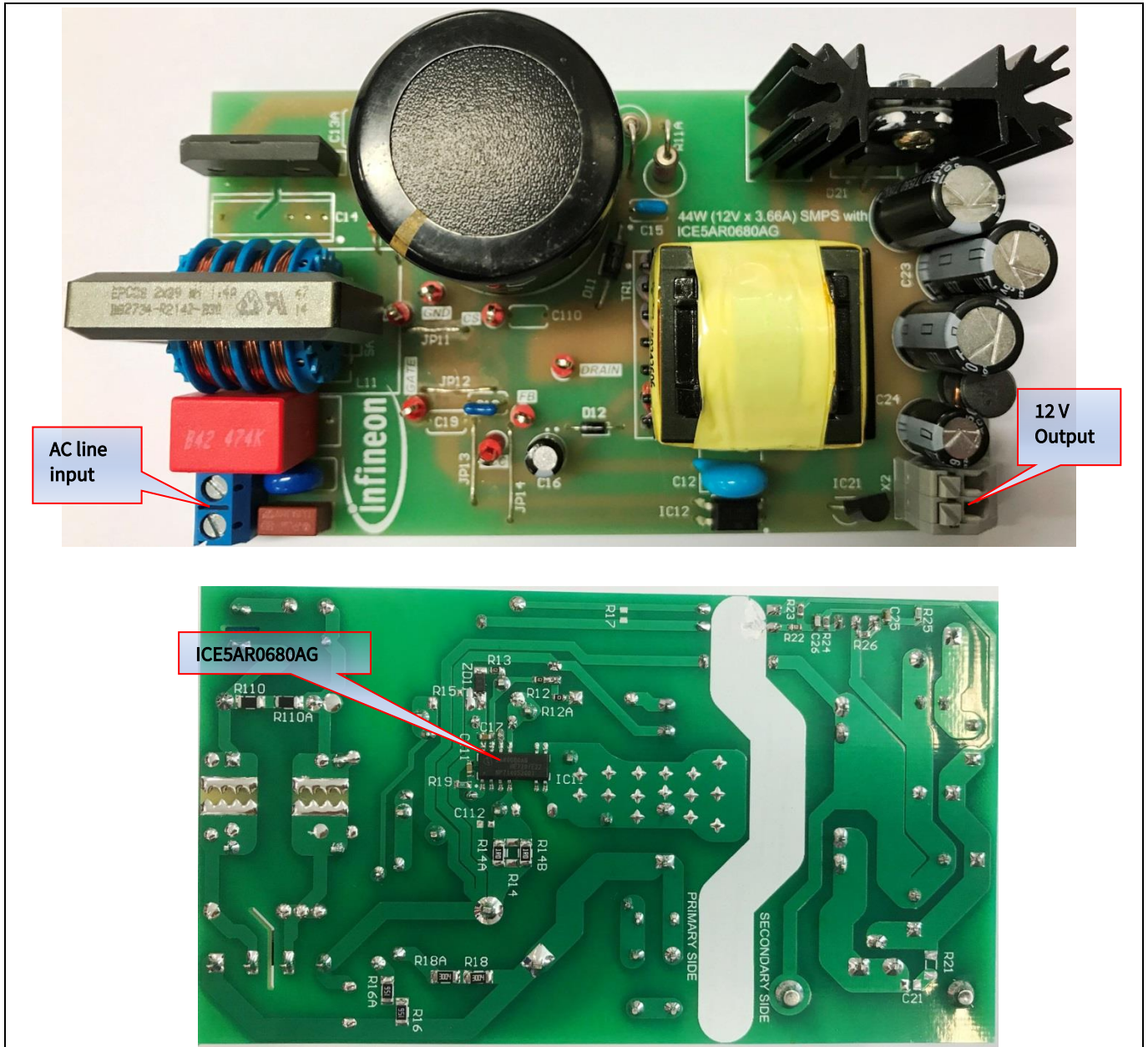

Figure 1 DEMO_5AR0680AG_44W1

3 Specifications of the demo board

Table 1 Specifications of DEMO_5AR0680AG_44W1

Input voltage and frequency	85 V AC (60 Hz) ~ 300 V AC (50 Hz)
Output voltage, current and power	12 V x 3.66 A = 44 W
Dynamic load response (12 V load change from 10% to 100%, slew rate at 0.4 A/ μ s, 100 Hz)	$\pm 3\%$ of nominal output voltage
Output ripple voltage (full load, 85 V AC ~ 300 V AC)	$12 V_{\text{ripple_p_p}} < 100 \text{ mV}$
Active-mode four-point average efficiency (25%, 50%, 75%, 100% load)	> 87% at 115 V AC and 230 V AC
No-load power consumption	< 100 mW at 230 V AC
Conducted emissions (EN 55022 class B)	Pass with 8 dB margin for 115 V AC and 6 dB margin 230 V AC
ESD immunity (EN 61000-4-2)	Level 4 for contact discharge and level 3 for air discharge ($\pm 8 \text{ kV}$ for both contact and air discharge)
Surge immunity (EN 61000-4-5)	Installation class 4 ($\pm 2 \text{ kV}$ for line-to-line and $\pm 4 \text{ kV}$ for line-to-earth)
Form factor case size (L x W x H)	(115 x 65 x 40) mm ³

4 Circuit description

4.1 Line input

The AC-line input side comprises the input fuse F1 as Over Current Protection (OCP). The choke L11, X-capacitor C11 and Y-capacitor C12 act as EMI suppressors. Optional spark-gap devices SA1, SA2 and varistor VAR can absorb HV stress during a lightning surge test. A rectified DC voltage (120 ~ 424 V DC) is obtained through the bridge rectifier BR1 together with bulk capacitor C13.

4.2 Start-up

To achieve fast and safe start-up, ICE5AR0680AG is implemented with a start-up resistor and VCC short-to-GND protection. When V_{VCC} reaches the turn-on voltage threshold 16 V, the IC begins with a soft-start. The soft-start implemented in ICE5AR0680AG is a digital time-based function. The preset soft-start time is 12 ms with four steps. If not limited by other functions, the peak voltage on the CS pin will increase step by step from 0.3 V to 0.8 V. After IC turn-on, the VCC voltage is supplied by auxiliary windings of the transformer. VCC short-to-GND protection is implemented during the start-up time.

4.3 Integrated CoolMOS™ with frequency-reduction controller

ICE5AR0680AG comprises a CoolMOS™ and the frequency-reduction controller, which enables better efficiency between light load and 50% load. This integrated solution greatly simplifies the circuit layout and reduces the cost of PCB manufacturing. The new CoolSET™ can be operated in either DCM or CCM with frequency-reduction mode. This demo board is designed to operate in CCM to increase efficiency under low-line full-load conditions. When the system is operating at maximum power, the controller will switch at the FF of 100 kHz. In order to achieve a better efficiency between light load and medium load, frequency reduction is implemented, and the reduction curve is shown in Figure 2. The V_{CS} is clamped by the current limitation threshold or by the PWM op-amp, while the switching frequency is reduced. After the maximum frequency reduction, the minimum switching frequency is f_{OSC2_MIN} (43 KHz).

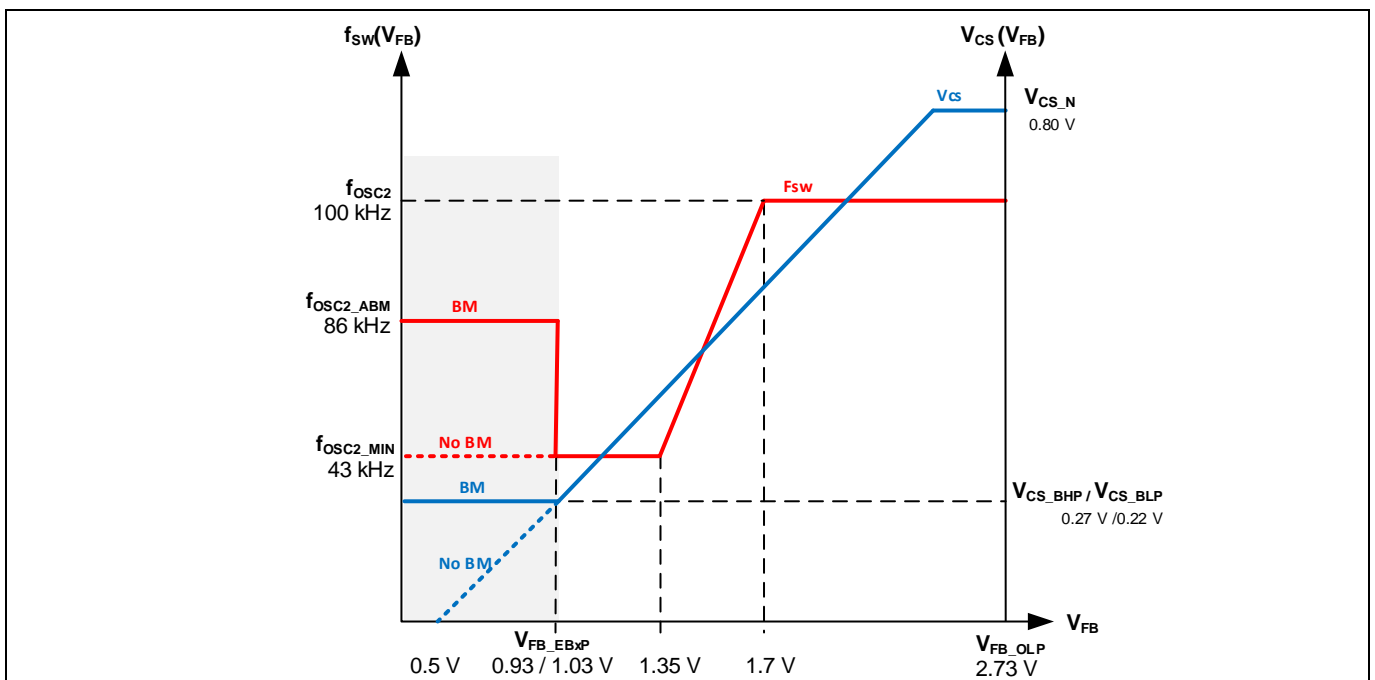

Figure 2 Frequency-reduction curve

Circuit description

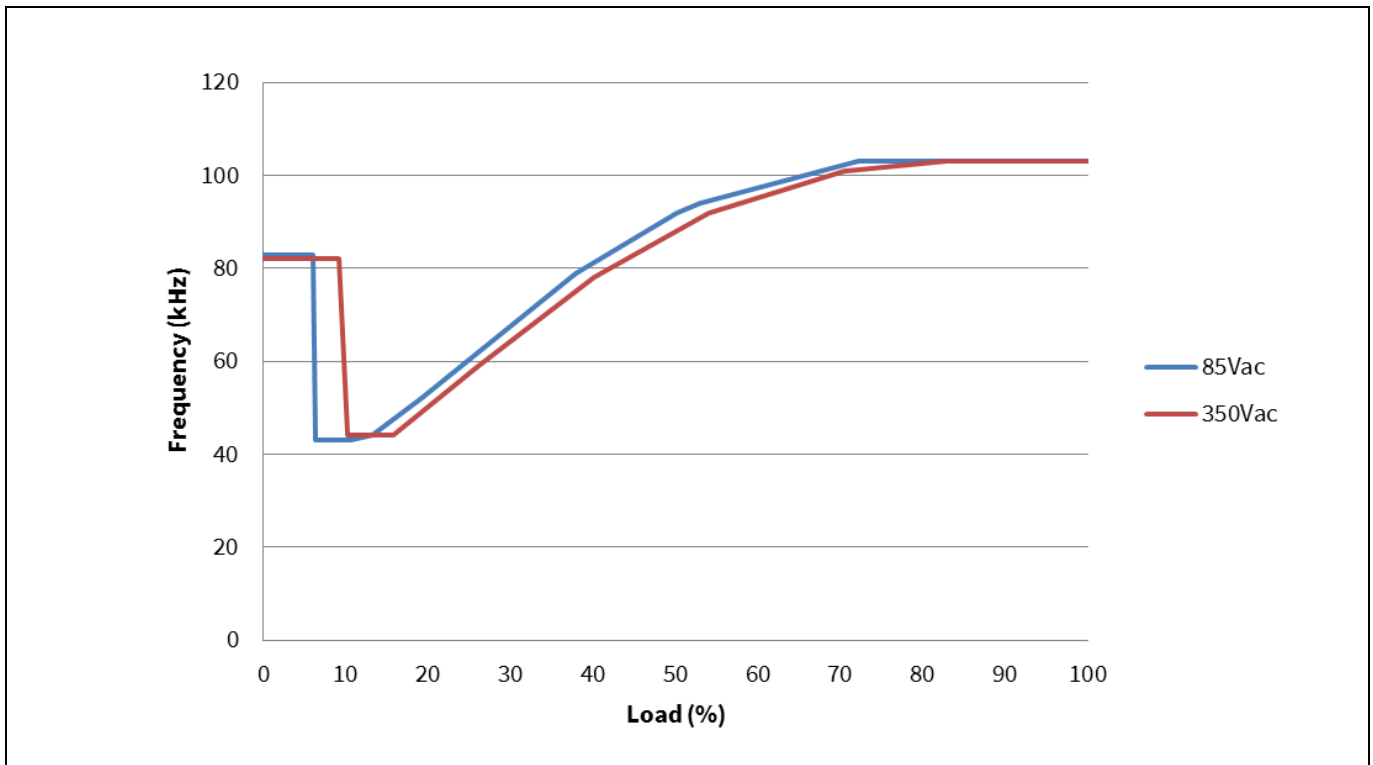

Figure 3 Frequency-reduction curve of DEMO_5AR0680AG_44W1

The measured frequency-reduction curve of DEMO_5AR0680AG_44W1 is shown in Figure 3.

4.4 Frequency jittering

The ICE5AR0680AG has a frequency-jittering feature to reduce the EMI noise. The jitter frequency is internally set at 100 kHz (± 4 kHz) and the jitter period is 4 ms.

4.5 RCD clamper circuit

A clamper network (R11, R11A, C15 and D11) dissipates the energy of the leakage inductance and suppresses ringing on the SMPS transformer.

4.6 Output stage

There is a single output on the secondary side, 12 V. The power is coupled out via Schottky diode D21. The capacitors C22, C23 and C23A provide energy buffering, followed by the L-C filters L21-C24 to reduce the output ripple and prevent interference between SMPS switching frequency and line frequency. Storage capacitors C22, C23 and C23A are designed to have an internal resistance (ESR) as small as possible to minimize the output voltage ripple caused by the triangular current.

4.7 FB loop

For feedback (FB), the output is sensed by the voltage dividers R26 and R25 and compared to the IC21 (TL431) internal reference voltage. C25, C26 and R24 comprise the compensation network. The output voltage of IC21 (TL431) is converted to the current signal via optocoupler IC12 and two resistors, R22 and R23, for regulation control.

Circuit description

4.8 Active Burst Mode (ABM)

ABM entry and exit power can be selected from three options, including no ABM. This demo board is set to option 3, and details are shown in the product datasheet. Under light-load conditions, the SMPS enters ABM. At this stage, the controller is always active but the V_{VCC} must be kept above the switch-off threshold. During ABM, the efficiency increases significantly and at the same time it supports low ripple on V_{out} and fast response on load-jump.

In order to enter ABM operation, two conditions must apply:

1. The FB voltage must be lower than the threshold of V_{FB_EBXP}
2. A certain blanking time ($t_{FB_BEB} = 36$ ms) is required

Once both of these conditions are fulfilled, the ABM flip-flop is set and the controller enters ABM operation. This dual-condition determination for entering ABM operation prevents mis-triggering of ABM, so that the controller enters ABM operation only when the output power is really low during the preset blanking time.

During ABM, switching frequency is reduced to 86 kHz for level 2 and 3 selections, and 43 kHz for level 1 (no ABM) to improve the efficiency during standby power measurement. The maximum CS voltage is reduced from V_{CS_N} to V_{CS_BXP} to reduce the conduction loss and the audible noise. During ABM, the FB voltage is changing like a sawtooth between $V_{FB_Bon_ISO}$ and $V_{FB_Boff_ISO}$.

The FB voltage immediately increases if there is a high load-jump. This is observed by one comparator. As the current limit is 27/33% during ABM a certain load is needed so that FB voltage can exceed V_{FB_LB} (2.75 V). After leaving ABM, maximum current can be provided to stabilize V_{out} .

5 Protection features

Protection is one of the major factors in determining whether the system is safe and robust – therefore sufficient protection is necessary. ICE5AR0680AG provides comprehensive protection to ensure the system is operating safely. This includes LOV, VCC OV/UV, over-load, over-temperature (controller junction), CS short-to-GND and VCC short-to-GND. When those faults are found, the system will go into protection mode. Once the fault is removed, the system resumes normal operation. A list of protections and failure conditions are shown in the table below.

Table 2 Protection functions of ICE5AR0680AG

Protection function	Failure condition	Protection mode
LOV	$V_{VIN} > 2.85 \text{ V}$	Non-switch auto restart
VCC OV	$V_{VCC} > 25.5 \text{ V}$	Odd-skip auto restart
VCC UV	$V_{VCC} < 10 \text{ V}$	Auto restart
Over-load	$V_{FB} > 2.73 \text{ V}$ and lasts for 54 ms	Odd-skip auto restart
Over-temperature (junction temperature of controller chip only)	$T_J > 140^\circ\text{C}$	Non-switch auto restart
CS short-to-GND	$V_{CS} < 0.1 \text{ V}$, lasts for 0.4 μs and three consecutive pulses	Odd-skip auto restart
VCC short-to-GND ($V_{VCC} = 0 \text{ V}$, start-up = 50 M Ω and $V_{DRAIN} = 90 \text{ V}$)	$V_{VCC} < 1.1 \text{ V}$, $I_{VCC_Charge1} \approx -0.2 \text{ mA}$	Cannot start up

6 Circuit diagram

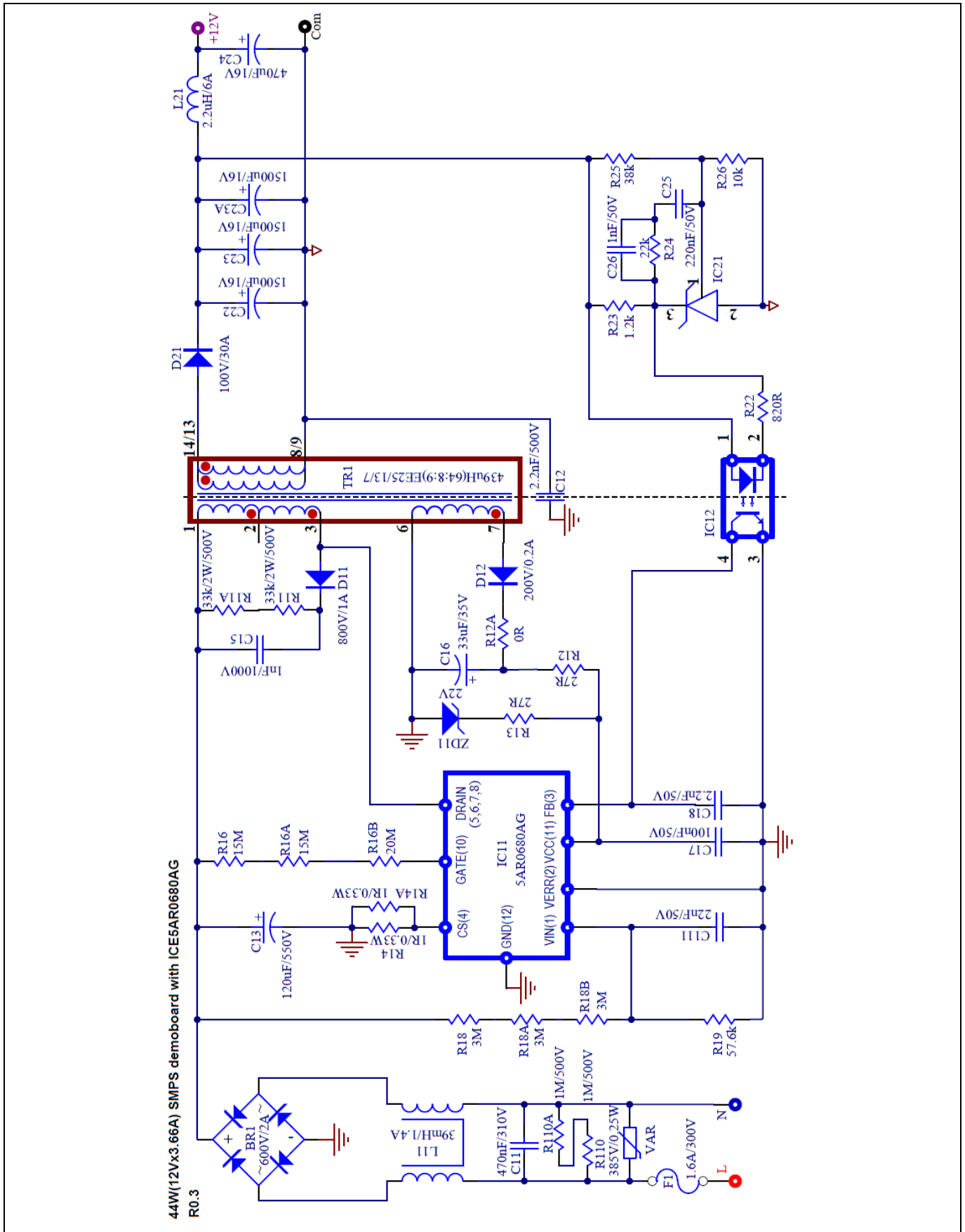

Figure 4 Schematic of DEMO_5AR0680AG_44W1

PCB layout

7 PCB layout

7.1 Top side

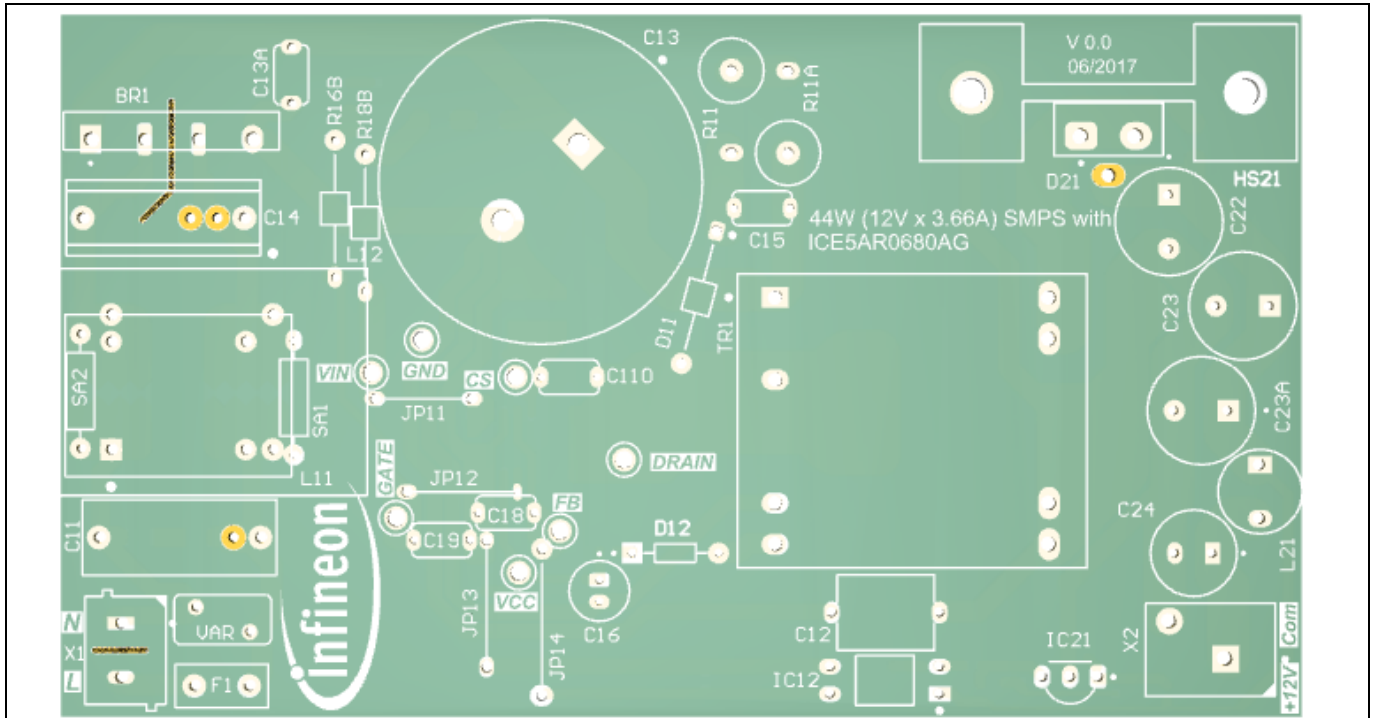

Figure 5 Top side component legend

7.2 Bottom side

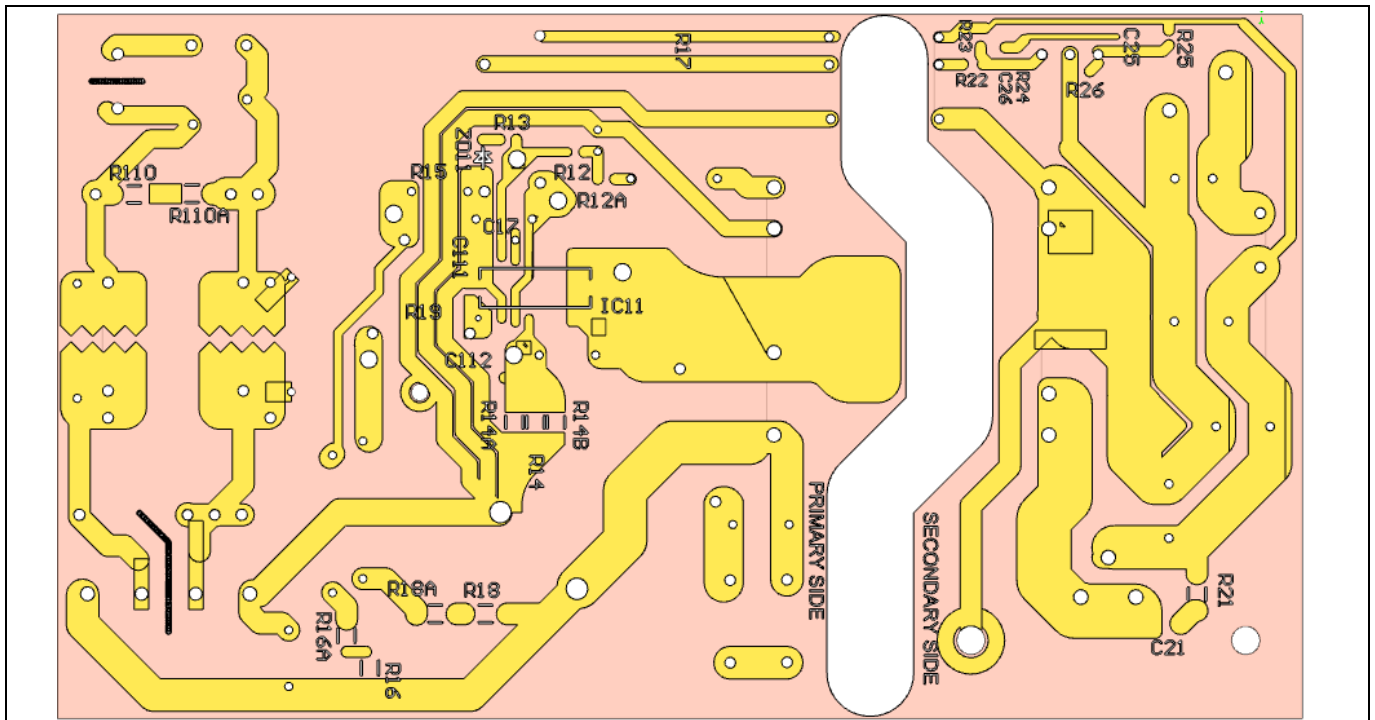

Figure 6 Bottom side copper and component legend

Bill of Materials (BOM)

8 Bill of Materials (BOM)

Table 3 BOM (R 0.2)

No.	Designator	Description	Part number	Manufacturer	Quantity
1	BR1	600 V/2 A	D2SB60A	Shindengen	1
2	C11	470 nF/310 V	890324024005	Wurth Electronics	1
3	C12	2.2 nF/500 V	DE1E3RA222MA4BQ	Murata	1
4	C13	120 uF/550 V	ALC10A121CC550		1
5	C15	1 nF/1000 V	RDER73A102K2K1H03	Murata	1
6	C16	33 uF/35 V	50PX33MEFC5X11	Rubycon	1
7	C17	100 nF/50 V	GRM188R71H104KA93D	Murata	1
8	C18	2.2 nF/50 V	RDE5C1H222J0K1H03B	Murata	1
9	C26	1 nF/50 V	GRM1885C1H102GA01D	Murata	1
10	C22, C23, C23A	1500 uF/16 V	16ZLH1500MEFC10X20	Rubycon	3
11	C24	470 uF/16 V	16ZLH470MEFC8X11.5	Rubycon	1
12	C25	220 nF/50 V	GRM188R71H224KAC4D	Murata	1
13	C111	22 nF/50 V	GCM188R71H223KA37D	Murata	1
14	D11	800 V/1 A	UF4006		1
15	D12	200 V/0.2 A	1N485B		1
16	D21	100 V/30 A	VF30100SG		1
17	F1	1.6 A/300 V	36911600000		1
18	FB @ pins 1 and 3 of TR1 and D11 anode	Ferrite bead	B64290P0035X038	Epcos	3
19	HS21	Heatsink	513002B02500G		1
20	IC11	5AR0680AG	5AR0680AG	Infineon	1
21	IC12	Optocoupler	SFH617A-3		1
22	IC21	Shunt regulator	TL431BVLPG		1
23	JP11, JP12, JP13, JP14	Jumper			4
24	L11	39 mH/1.4 A	B82734R2142B030	Epcos	1
25	L21	2.2 uH/6 A	744772022	Wurth Electronics	1
26	R11, R11A	33 k/2 W/500 V	PR02000203302JR500		2
27	R12, R13	27 R	0603 RESISTOR		2
28	R12A	0 R	0603 RESISTOR		1
29	R14A, R14B	1 R/0.33 W	ERJ8BQF1R0V		2
30	R16, R16A	15 M	1206 RESISTOR		2
31	R16B	20 M, 0.125 W (axial leaded)	CF18JT20M0		1
32	R18, R18A	3 M	1206 RESISTOR		2
33	R18B	3 M, 0.125 W (axial leaded)	CF18JT3M00		1
34	R19	57.6k	ERA-3AEB57R6V		1
35	R22	820 R	0603 RESISTOR		1
36	R23	1.2 k	0603 RESISTOR		1
37	R24	22 k	0603 RESISTOR		1
38	R25	38 k	0603 RESISTOR		1
39	R26	10 k	0603 RESISTOR		1
40	R110, R110A	1 M/500 V	1206 RESISTOR		2
41	TR1	439 uH (64:8:9) EE25/13/7	750343606(R0.2)	Wurth Electronics	1
42	Test point for VIN, VERR, FB, VCC, CS, DRAIN, GATE and GND	Test point	5010		7

Bill of Materials (BOM)

43	VAR	385 V/0.25 W	B72207S0381K101	Epcos	1
44	X1	Connector	691102710002	Wurth Electronics	1
45	X2	Connector	691412120002B	Wurth Electronics	1
46	ZD11	22 V (SOD123)	MMSZ5251B-7-F	Wurth Electronics	1

Transformer construction

9 Transformer construction

Core and materials: EE25/13/7 (EF25), TP4A (TDG)

Bobbin: 070-5644 (14-pin, THT, horizontal version)

Primary inductance: $L_p = 439 \mu\text{H}$ ($\pm 10\%$), measured between pin 1 and pin 3

Manufacturer and part number: Würth Electronics Midcom (750343606 R02)

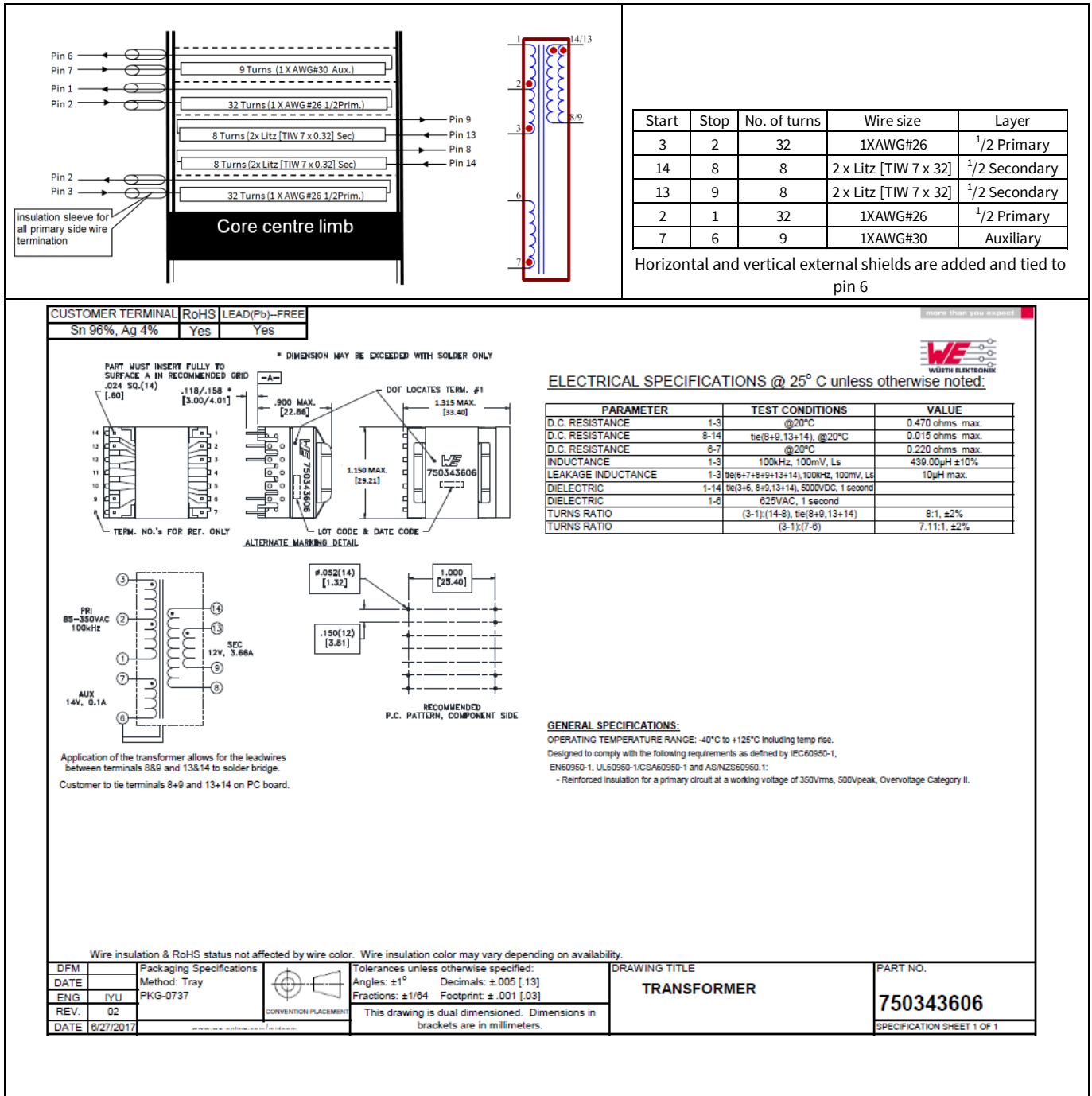

Figure 7 Transformer structure

10 350 V_{AC} operating voltage

If user wants to operate up to 350 V_{AC} and line OVP at 370 V_{AC}, the following changes are needed in the demo board.

Table 4 Changes for 350 Vac line voltage

No.	Designator	Description	Part Number	Manufacturer	Quantity
1	C11	330nF/350V _{AC}	C4BR2334K6WC000101		1
2	F1	1.6A/350 V _{AC}	0697W1600-05		1
3	L11	39mH/1.4A/350V _{AC}			1
4	R19	50.5k	PAT0603E50R5BST5		1

10.1 Line over voltage protection at 370 V_{AC} (Non switch Auto Restart)

Below oscillogram shows the line over voltage protection at 370 V_{AC}.

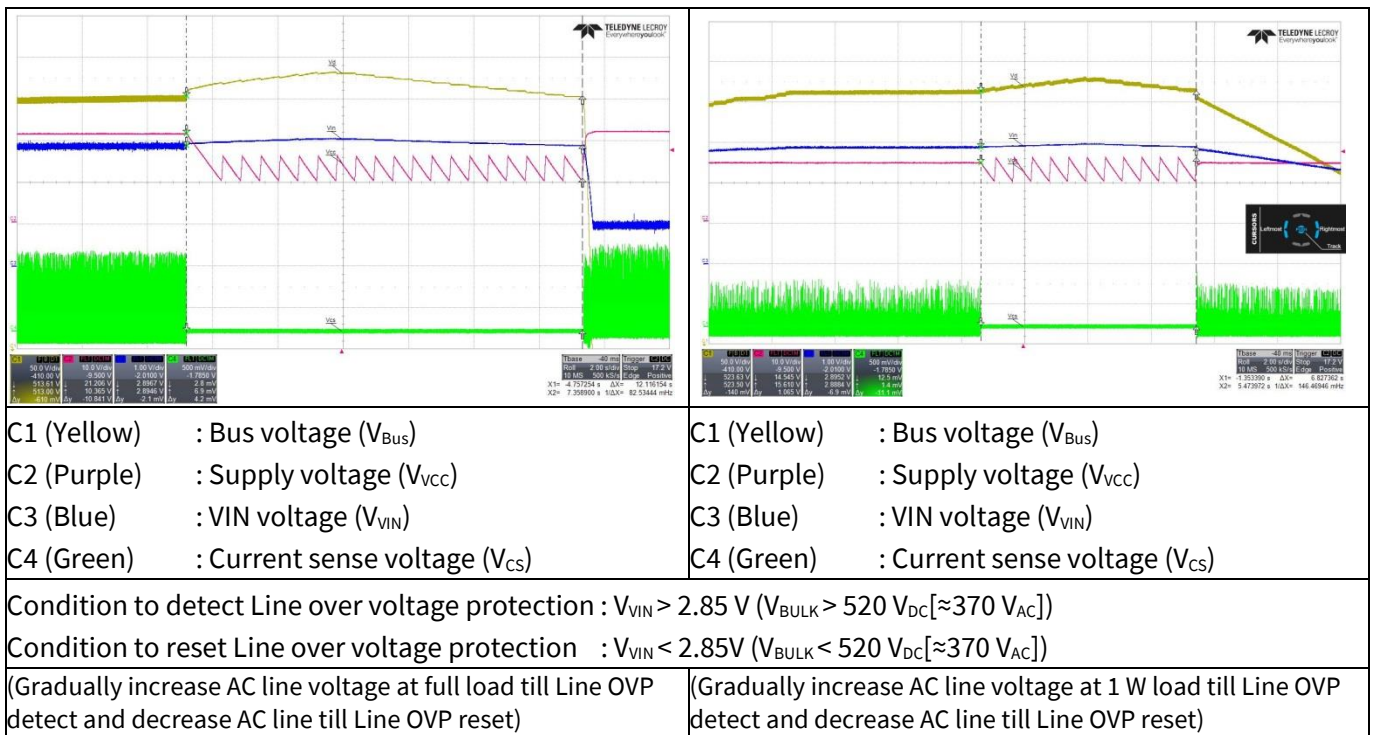

Figure 8 Line over voltage protection at 370 V_{AC}

10.2 Drain and current sense voltage at 350 V_{AC} and maximum load

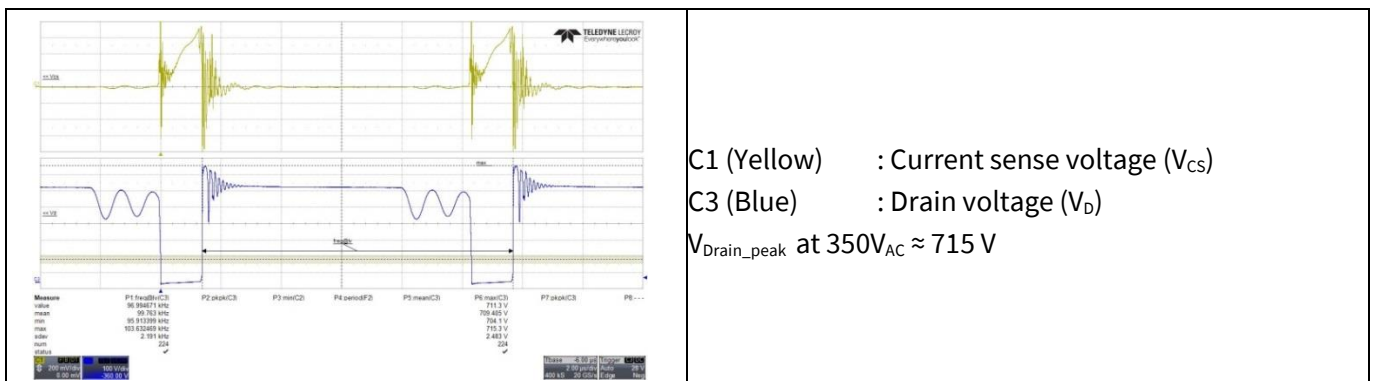

Figure 9 Drain and current sense voltage at 350 V_{AC} and maximum load

Test results

11 Test results

11.1 Efficiency, regulation and output ripple

Table 5 Efficiency, regulation and output ripple

Input (V AC/Hz)	P _{in} (W)	V ₁₂ (V DC)	I ₁₂ (A)	V _{12RPP} (mV)	P _{out} (W)	Efficiency η (%)	Average η (%)	OLP P _{in} (W)	OLP I _{out12V} (A)
85 V AC/60 Hz	0.03959	12.04	0.000	58	/	/	85.74	60.80	4.20
	12.64	12.03	0.913	14	10.98	86.89			
	25.51	12.02	1.833	17	22.03	86.37			
	38.51	12.01	2.743	24	32.94	85.55			
	52.19	12.00	3.660	33	43.92	84.15			
115 V AC/60 Hz	0.04570	12.04	0.000	58	/	/	87.07	65.20	4.60
	12.56	12.03	0.913	14	10.98	87.45			
	25.18	12.02	1.833	16	22.03	87.50			
	37.81	12.01	2.743	20	32.94	87.13			
	50.95	12.00	3.660	22	43.92	86.20			
230 V AC/50 Hz	0.08455	12.04	0.000	61	/	/	87.75	71.50	5.10
	12.63	12.03	0.913	14	10.98	86.96			
	25.05	12.02	1.833	16	22.03	87.95			
	37.42	12.01	2.743	20	32.94	88.04			
	49.89	12.00	3.660	22	43.92	88.03			
265 V AC/50 Hz	0.10087	12.04	0.000	63	/	/	87.39	72.00	5.26
	12.69	12.03	0.913	13	10.98	86.55			
	25.18	12.02	1.833	16	22.03	87.50			
	37.54	12.01	2.743	20	32.94	87.76			
	50.05	12.00	3.660	22	43.92	87.75			
300 V AC/50 Hz	0.12159	12.04	0.000	63	/	/	87.00	72.70	5.31
	12.80	12.03	0.913	14	10.98	85.81			
	25.34	12.02	1.833	15	22.03	86.95			
	37.56	12.01	2.743	19	32.94	87.71			
	50.18	12.00	3.660	22	43.92	87.52			
350 V AC/50 Hz ¹	0.15446	12.04	0.000	63	/	/	86.83	73.20	5.34
	12.87	12.03	0.913	13	10.98	85.34			
	25.39	12.02	1.833	14	22.03	86.78			
	37.68	12.01	2.743	18	32.94	87.43			
	50.03	12.00	3.660	20	43.92	87.79			

¹ Follow section 10 and measured with YOKOGAWA POWER METER (WT310HC), CHROMA AC SOURCE MODEL 61504 AND CHROMA AC TRANSFORM UNIT A615003

Test results

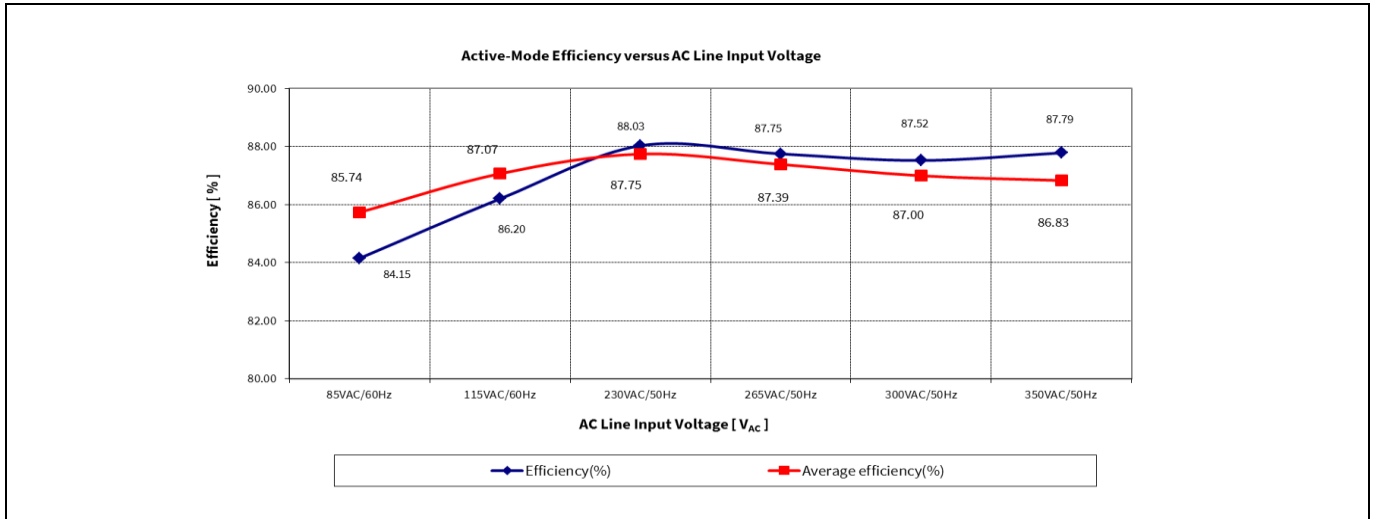

Figure 10 Efficiency vs AC-line input voltage

11.2 Standby power

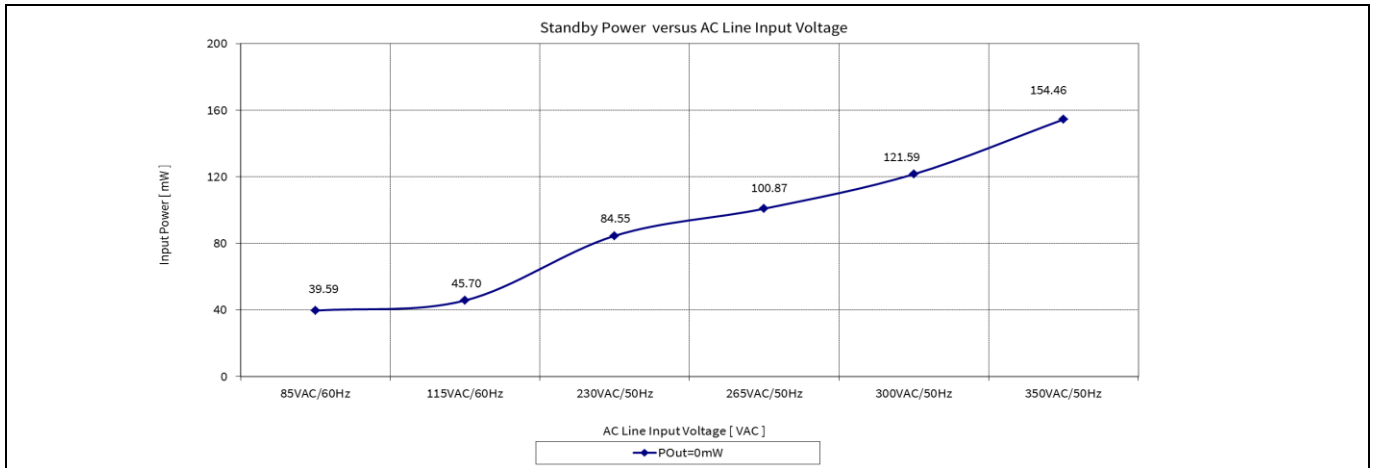

Figure 11 Standby power at no-load vs AC-line input voltage (measured by Yokogawa WT210 power meter – integration mode)

11.3 Line regulation

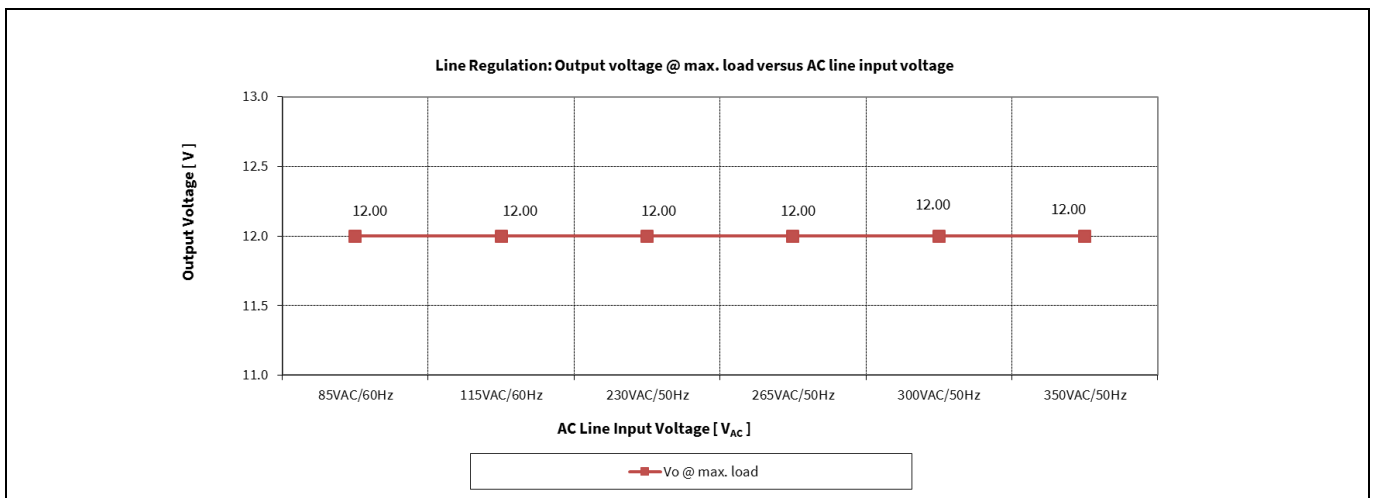

Figure 12 Line regulation V_{out} at full load vs AC-line input voltage

Test results

11.4 Load regulation

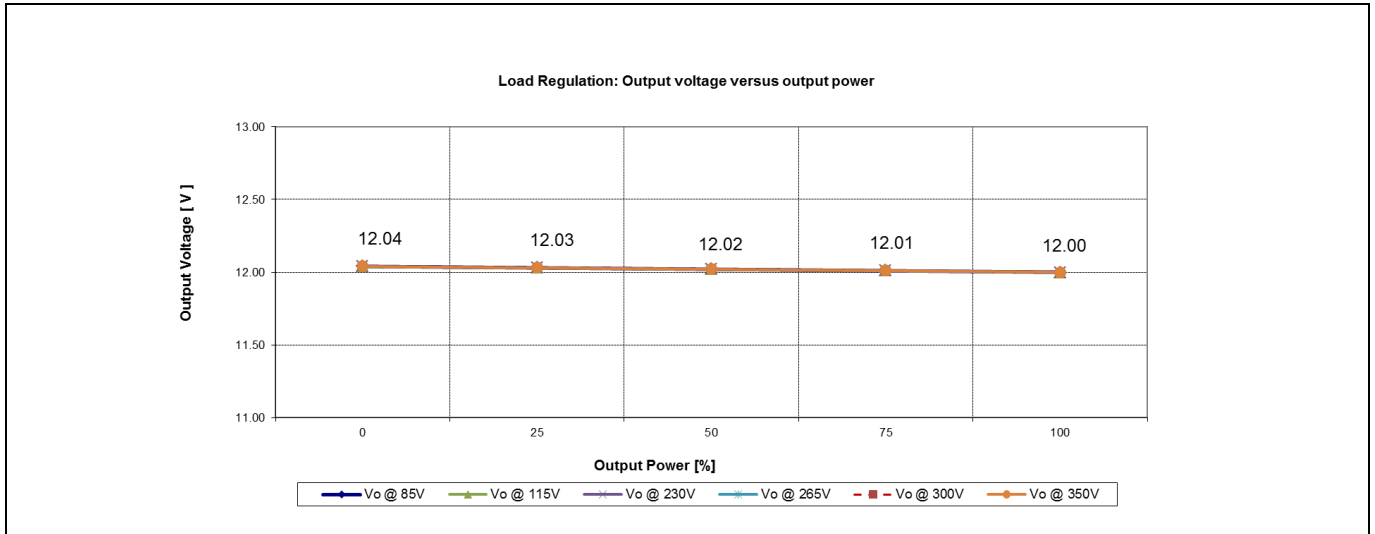

Figure 13 Load regulation V_{out} vs output power

11.5 Maximum input power

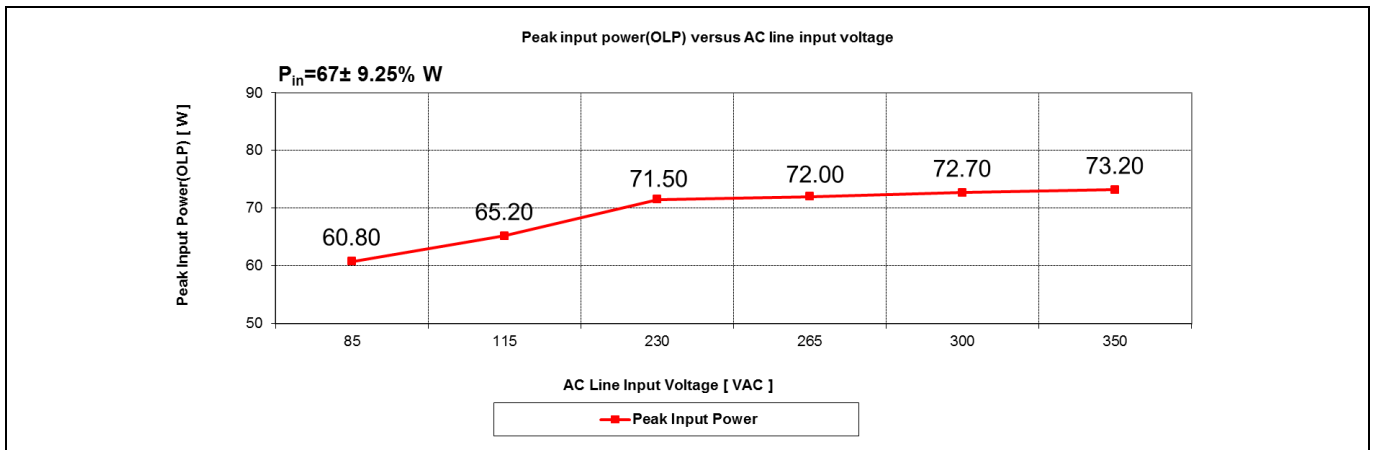

Figure 14 Maximum input power (before over-load protection) vs AC-line input voltage

11.6 ESD immunity (EN 61000-4-2)

Pass EN 61000-4-2 level 4 for contact discharge and level 3 for air discharge (± 8 kV for both contact and air discharge).

11.7 Surge immunity (EN 61000-4-5)

Pass EN 61000-4-5 installation class 4 (± 2 kV for line-to-line and ± 4 kV for line-to-earth).

11.8 Conducted emissions (EN 55022 class B)

The conducted EMI was measured by Schaffner (SMR4503) and followed the test standard of EN 55022 (CISPR 22) class B. The demo board was set up at maximum load (44 W) with input voltage of 115 V AC and 230 V AC.

Pass conducted emissions EN 55022 (CISPR 22) class B with 8 dB margin for low-line (115 V AC) and 6 dB margin for high-line (230 V AC).

Test results

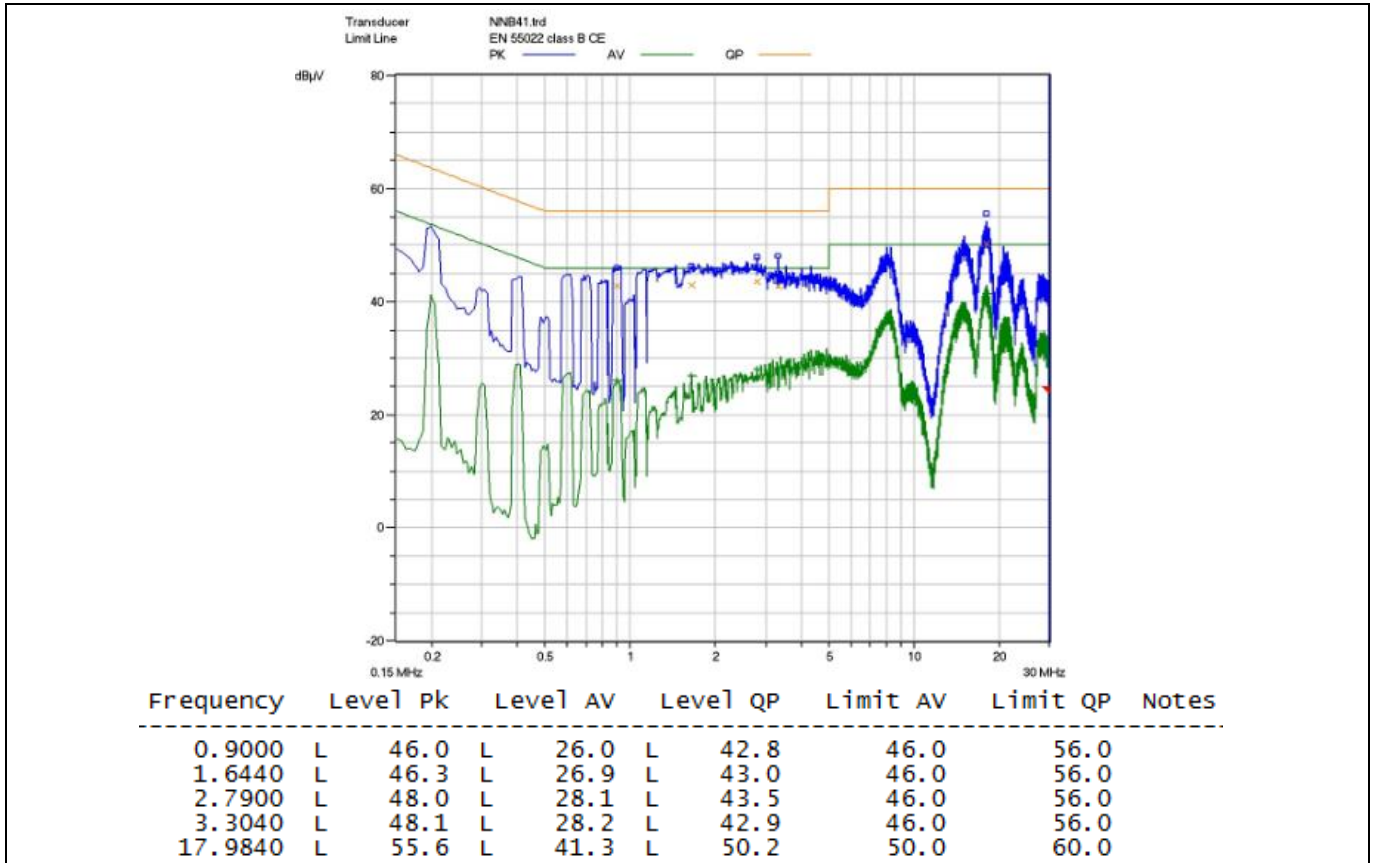

Figure 15 Conducted emissions (line) at 115 V AC and maximum load

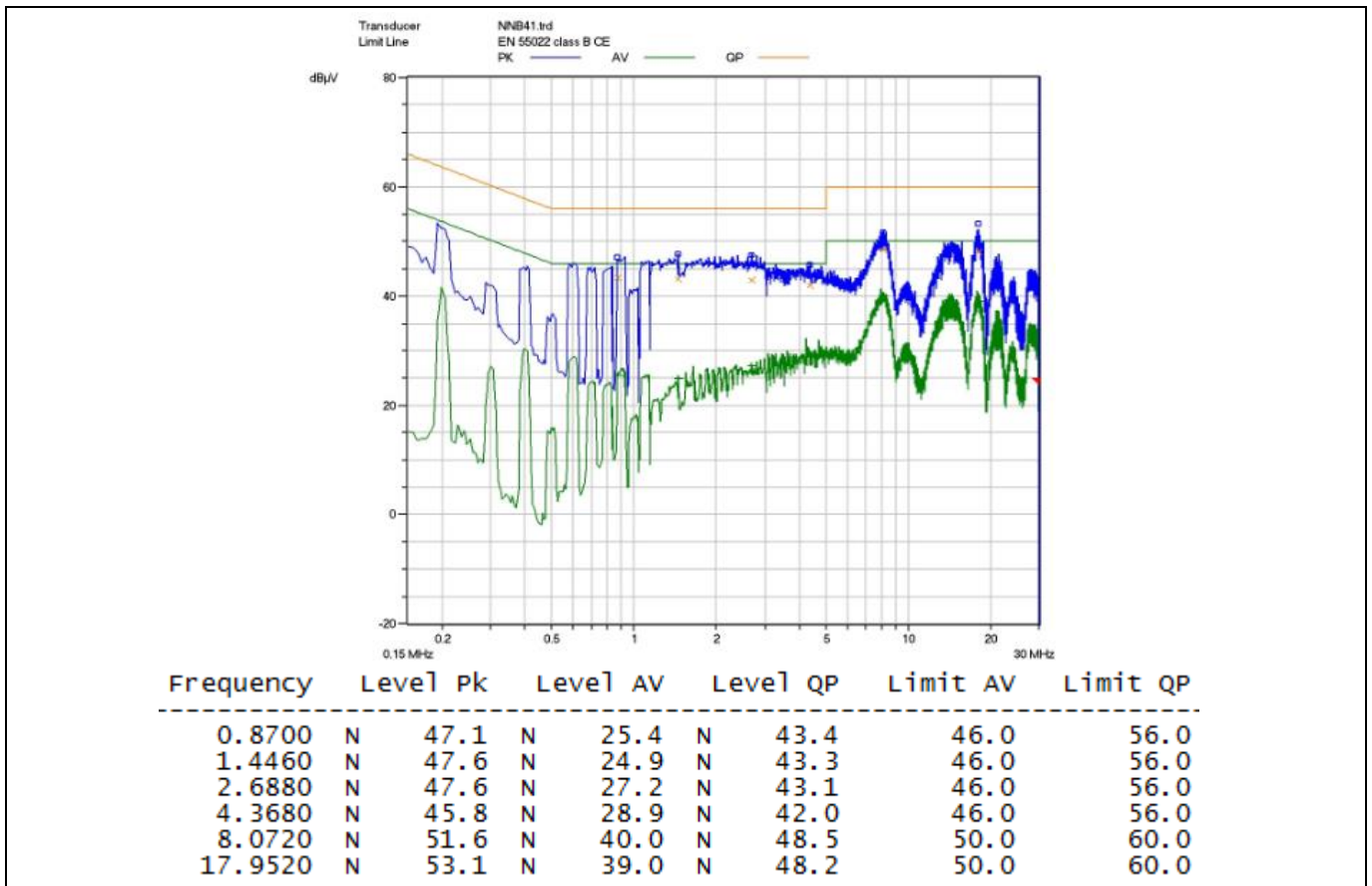

Figure 16 Conducted emissions (neutral) at 115 V AC and maximum load

Test results

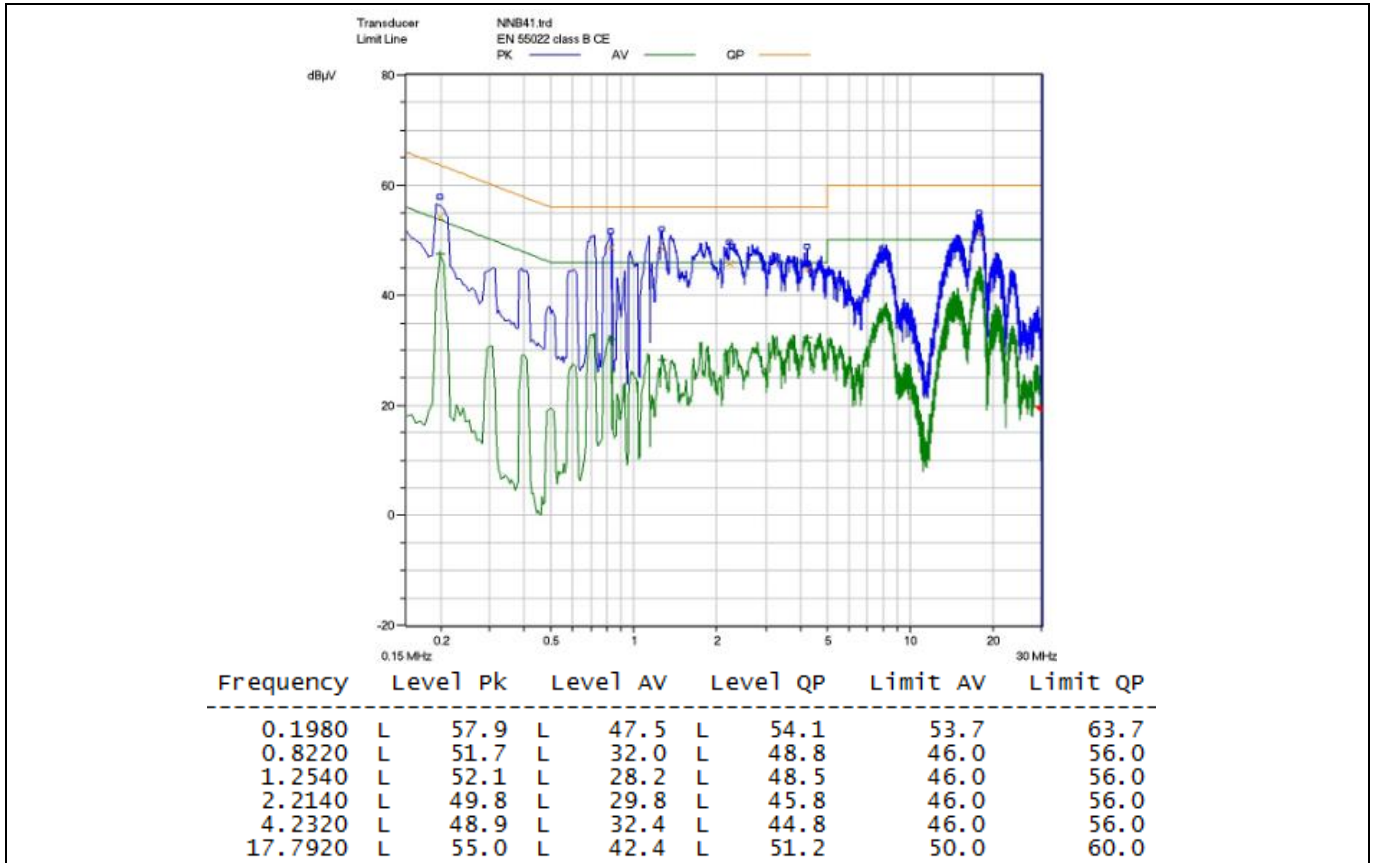

Figure 17 Conducted emissions (line) at 230 V AC and maximum load

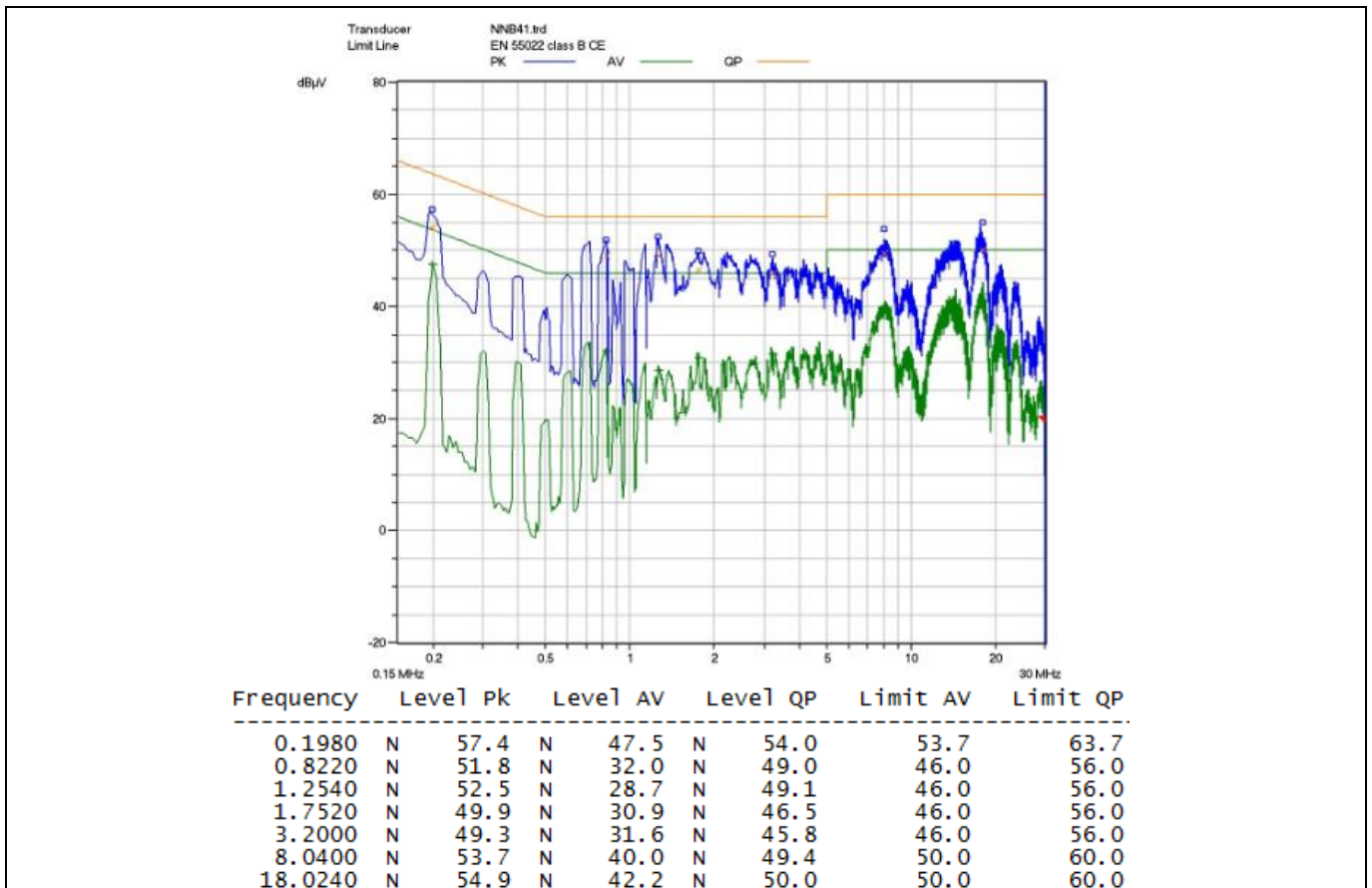

Figure 18 Conducted emissions (neutral) at 230 V AC and maximum load

Test results

11.9 Thermal measurement

The thermal test of the open-frame demo board was done using an infrared thermography camera (FLIR-T62101) at an ambient temperature of 25°C. The measurements were taken after one hour running at full load.

Table 6 Hottest temperature of demo board

No.	Major component	85 V AC (°C)	350 V AC (°C) ¹
1	IC11 (ICE5AR0680AG)	87.3	86.3
2	R14 (CS resistor)	62.7	47.5
3	TR1 (transformer)	60.3	72.3
4	BR1 (bridge diode)	60.4	35.2
5	D11(clamper diode)	64.0	64.3
6	L11 (choke)	54.2	30.8
7	D21 (secondary diode)	64.5	65.4
8	Ambient	25.0	25.0

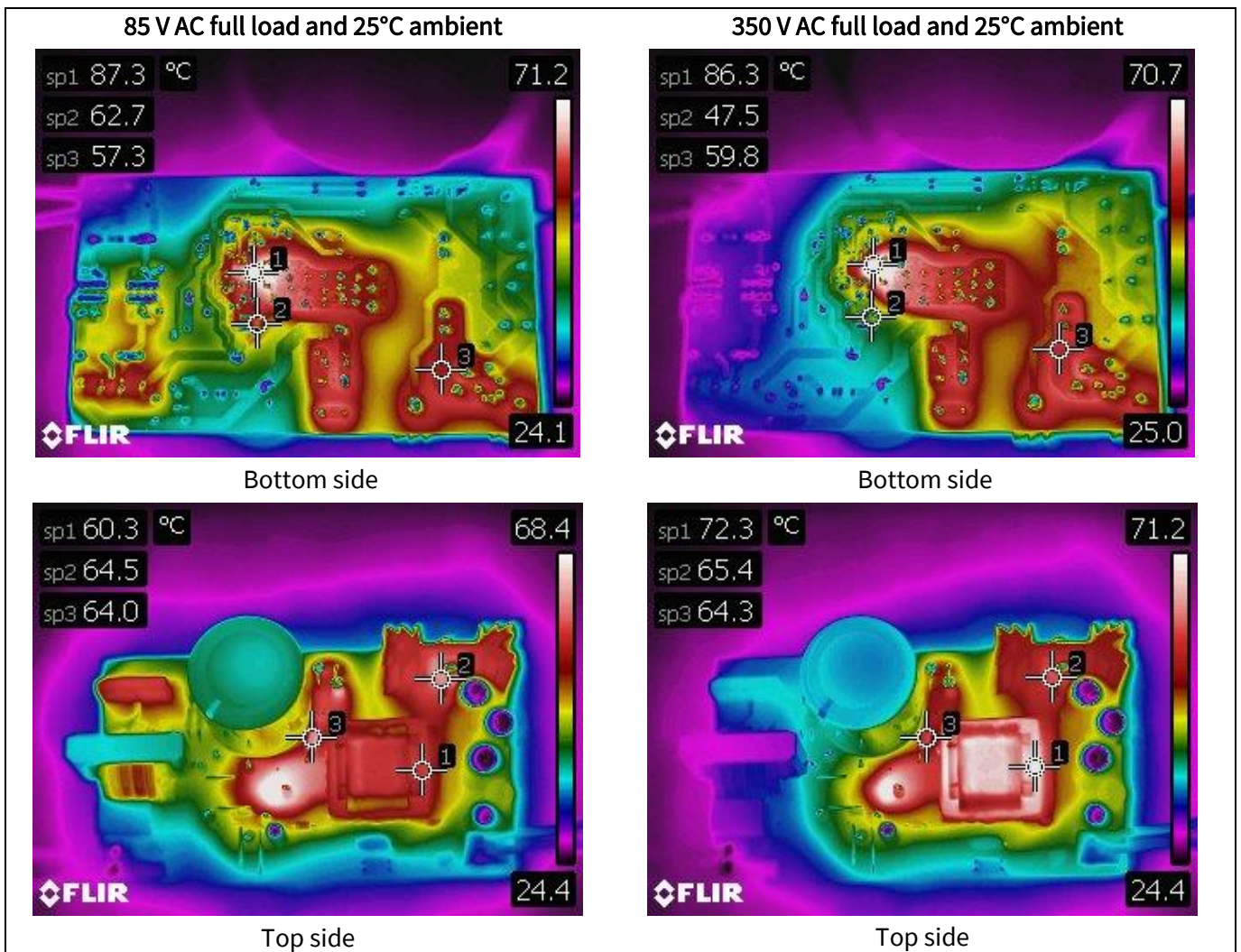

Figure 19 Infrared thermal image of DEMO_5AR0680AG_44W1

¹ Follow section 10

Waveforms and scope plots

12 Waveforms and scope plots

All waveforms and scope plots were recorded with a TELEDYNELECROY 606Zi oscilloscope.

12.1 Start-up at low/high AC-line input voltage with maximum load

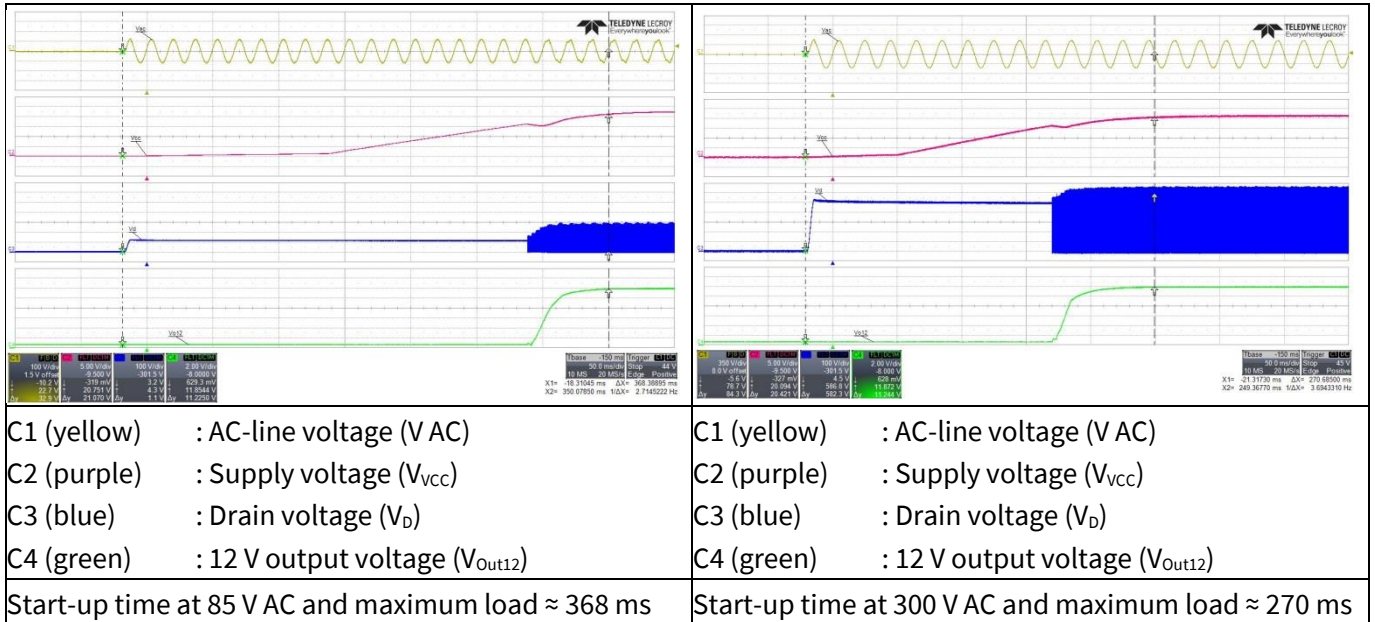

Figure 20 Start-up

12.2 Soft-start

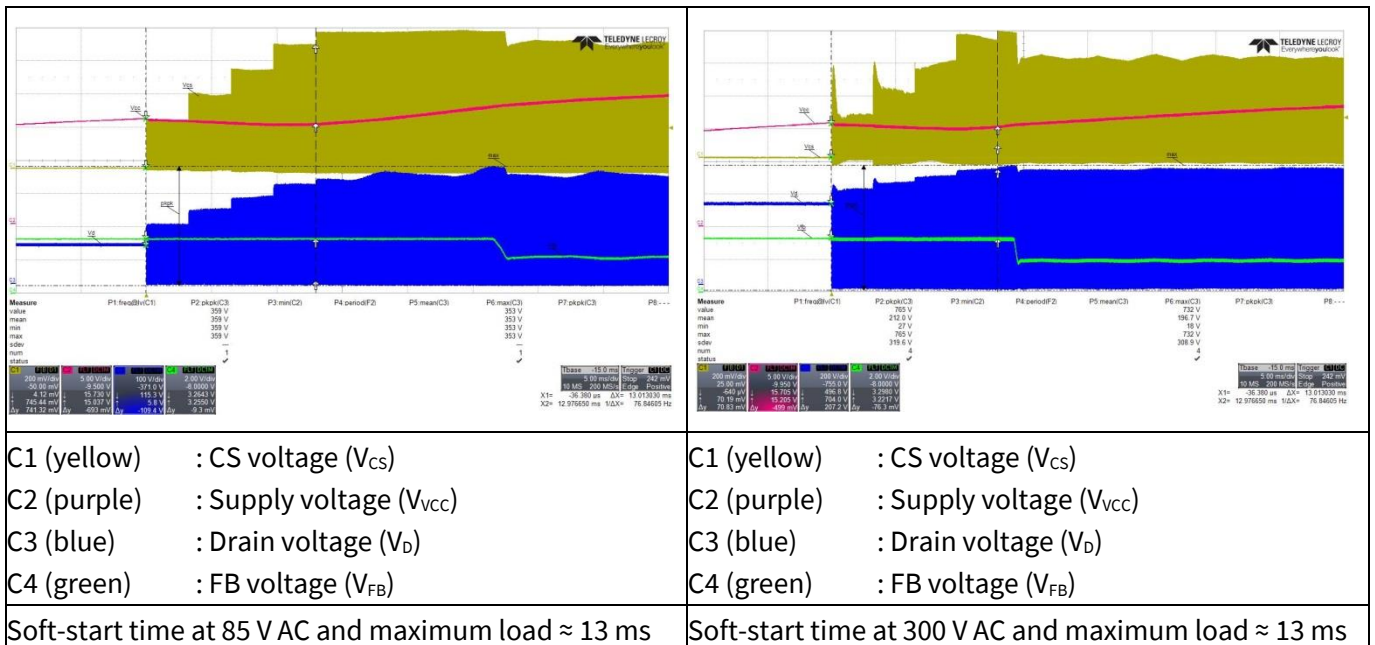
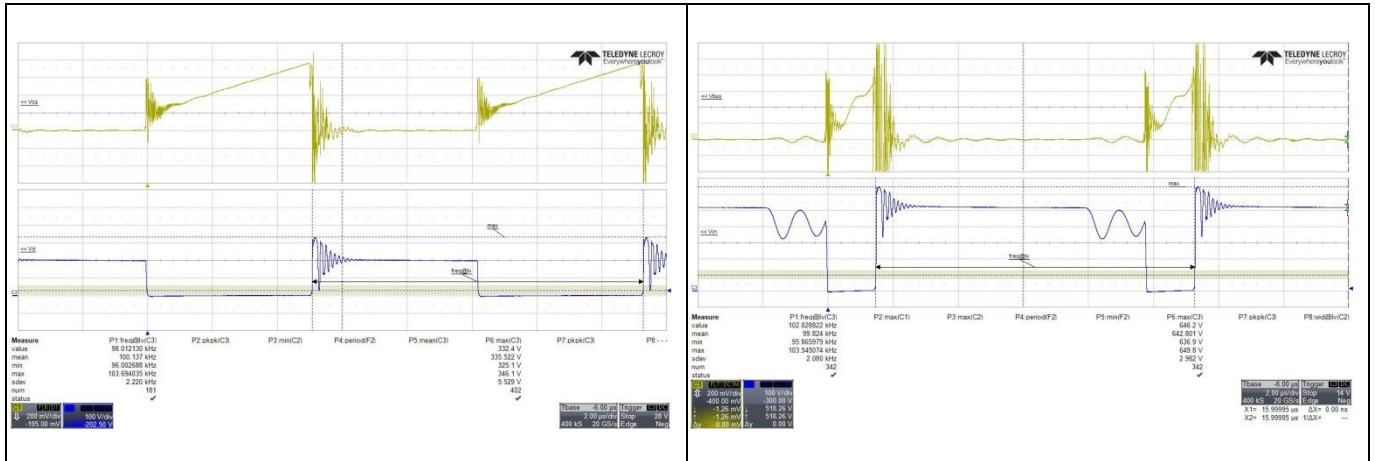

Figure 21 Soft-start

Waveforms and scope plots

12.3 Drain and CS voltage at maximum load



C1 (yellow) : CS voltage (V_{CS})

C3 (blue) : Drain voltage (V_D)

V_{Drain_peak} at 85 V AC \approx 346 V

C1 (yellow) : CS voltage (V_{CS})

C3 (blue) : Drain voltage (V_D)

V_{Drain_peak} at 300 V AC \approx 650 V

Figure 22 Drain and CS voltage at maximum load

12.4 Frequency jittering

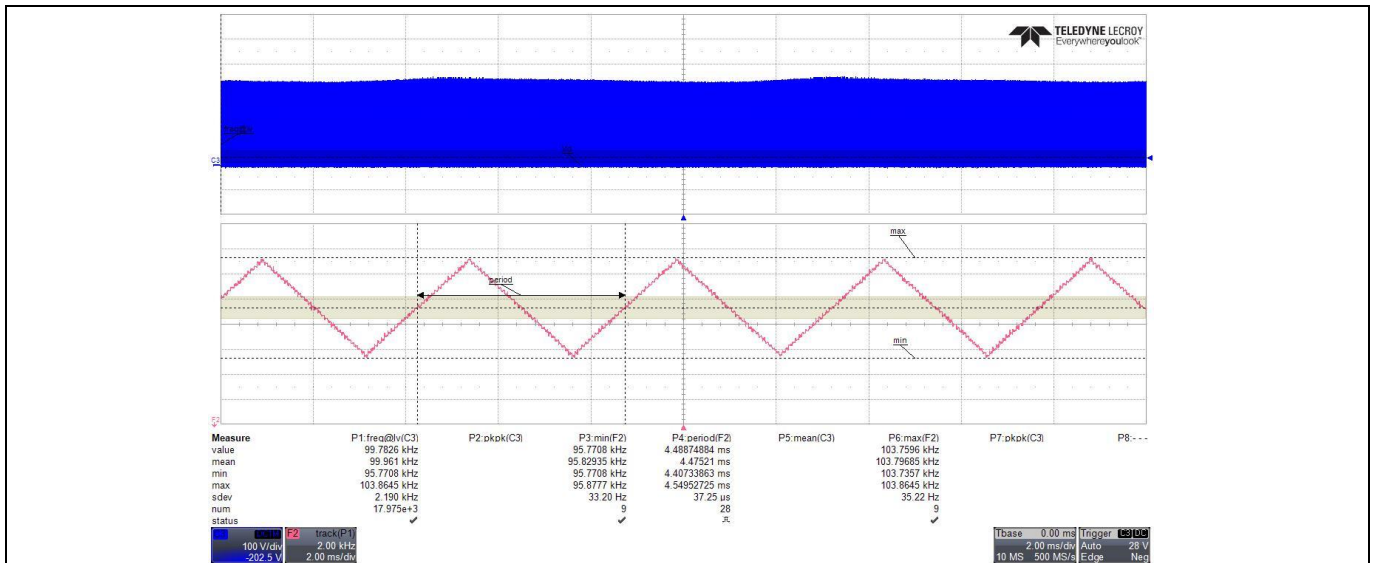

C3 (blue) : Drain voltage (V_D)

F2 (purple) : Frequency track of drain

Frequency jittering at 85 V AC and maximum load \approx 95 kHz ~ 103 kHz, jitter period is \approx 4.4 ms

Figure 23 Frequency jittering

Waveforms and scope plots

12.5 Load transient response (dynamic load from 10% to 100%)

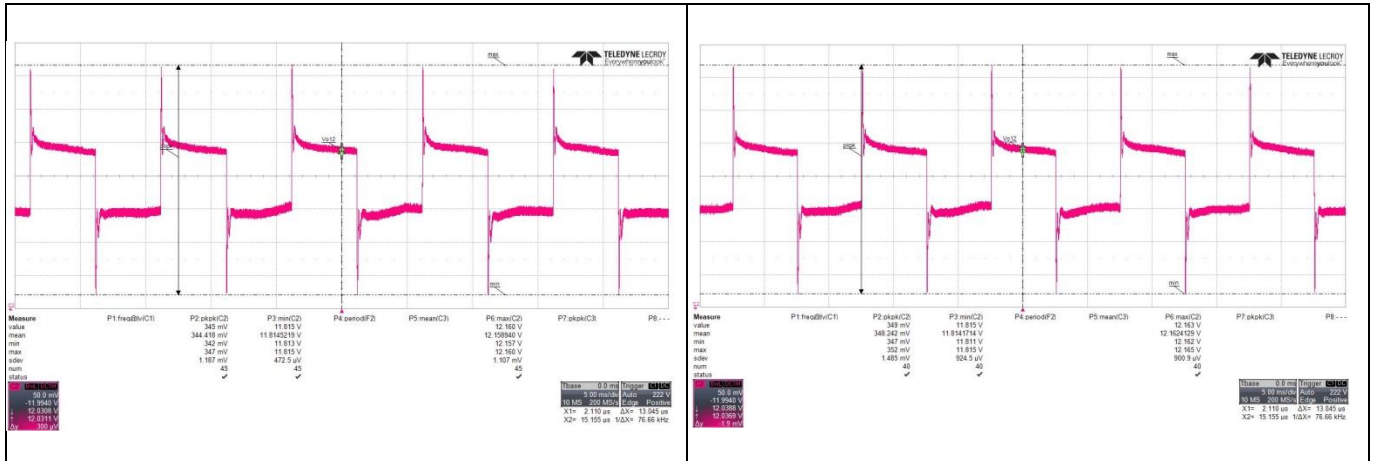

C2 (purple) : 12 V output ripple voltage (V_{Out12})
 $12 V_{ripple_pk_pk}$ at 85 V AC ≈ 347 mV
 (85 V AC, 12 V load change from 10% to 100%, 100 Hz, 0.4 A/ μ s slew rate)
 Probe terminal end with decoupling capacitor of 0.1 μ F (ceramic) and 1 μ F (electrolytic), 20 MHz filter

C2 (purple) : 12 V output ripple voltage (V_{Out12})
 $12 V_{ripple_pk_pk}$ at 300 V AC ≈ 352 mV
 (300 V AC, 12 V load change from 10% to 100%, 100 Hz, 0.4 A/ μ s slew rate)
 Probe terminal end with decoupling capacitor of 0.1 μ F (ceramic) and 1 μ F (electrolytic), 20 MHz filter

Figure 24 Load transient response

12.6 Output ripple voltage at maximum load

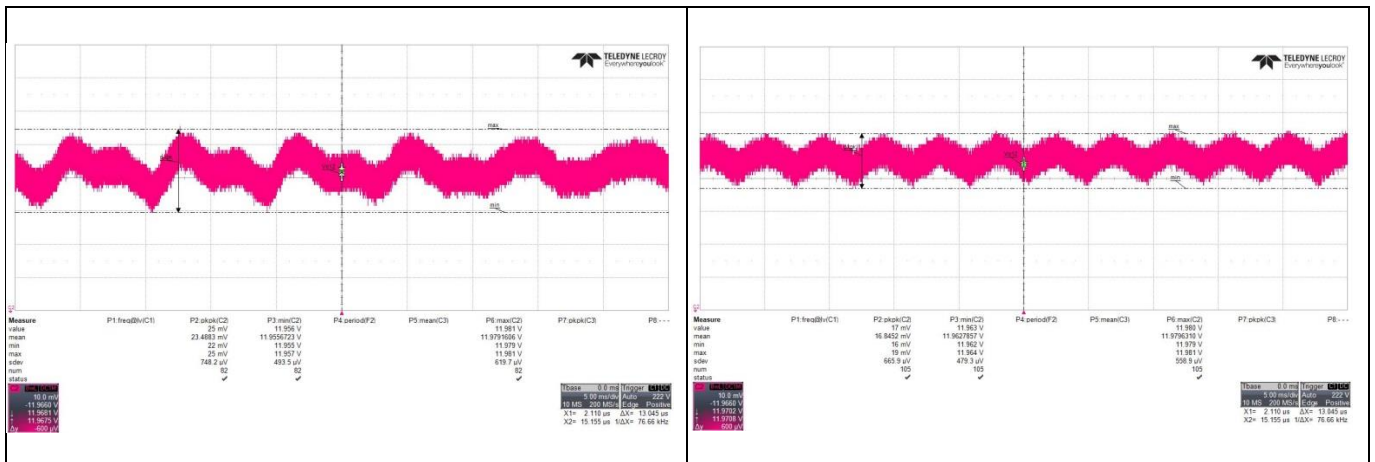

C2 (purple) : 12 V output ripple voltage (V_{Out12})
 $12 V_{ripple_pk_pk}$ at 85 V AC ≈ 27 mV
 Probe terminal end with decoupling capacitor of 0.1 μ F (ceramic) and 1 μ F (electrolytic), 20 MHz filter

C2 (purple) : 12 V output ripple voltage (V_{Out12})
 $12 V_{ripple_pk_pk}$ at 300 V AC ≈ 20 mV
 Probe terminal end with decoupling capacitor of 0.1 μ F (ceramic) and 1 μ F (electrolytic), 20 MHz filter

Figure 25 Output ripple voltage at maximum load

Waveforms and scope plots

12.7 Output ripple voltage at ABM 1 W load

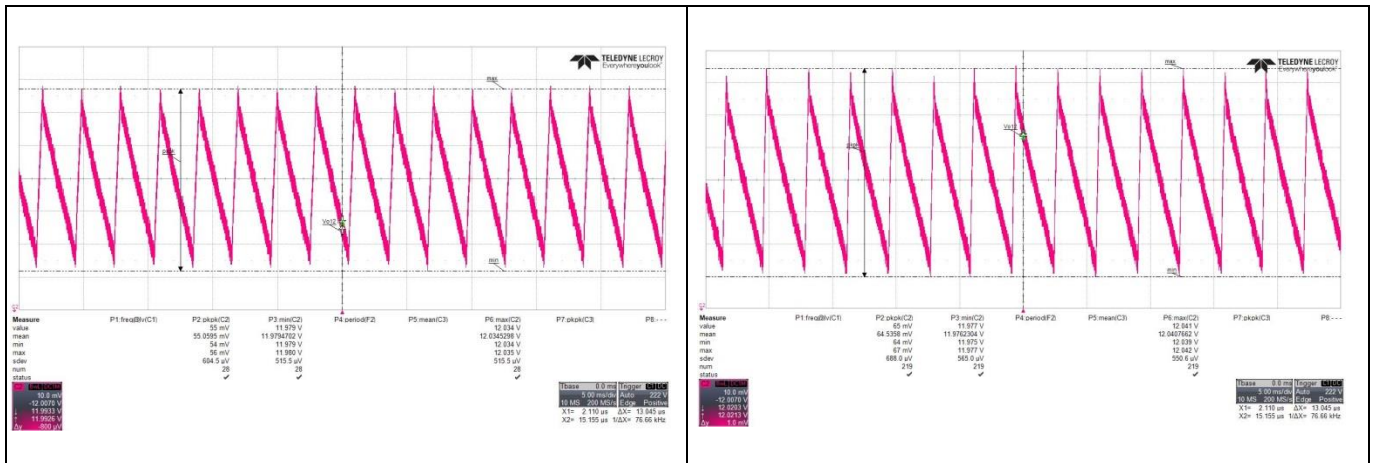

C2 (purple) : 12 V output ripple voltage (V_{Out12})
 $12 V_{ripple_pk_pk}$ at 85 V AC ≈ 57 mV
 Load: 12 V at 83 mA
 Probe terminal end with decoupling capacitor of 0.1 μ F (ceramic) and 1 μ F (electrolytic), 20 MHz filter

C2 (purple) : 12 V output ripple voltage (V_{Out12})
 $12 V_{ripple_pk_pk}$ at 300 V AC ≈ 67 mV
 Load: 12 V at 83 mA
 Probe terminal end with decoupling capacitor of 0.1 μ F (ceramic) and 1 μ F (electrolytic), 20 MHz filter

Figure 26 Output ripple voltage at burst mode 1 W load

12.8 Entering ABM

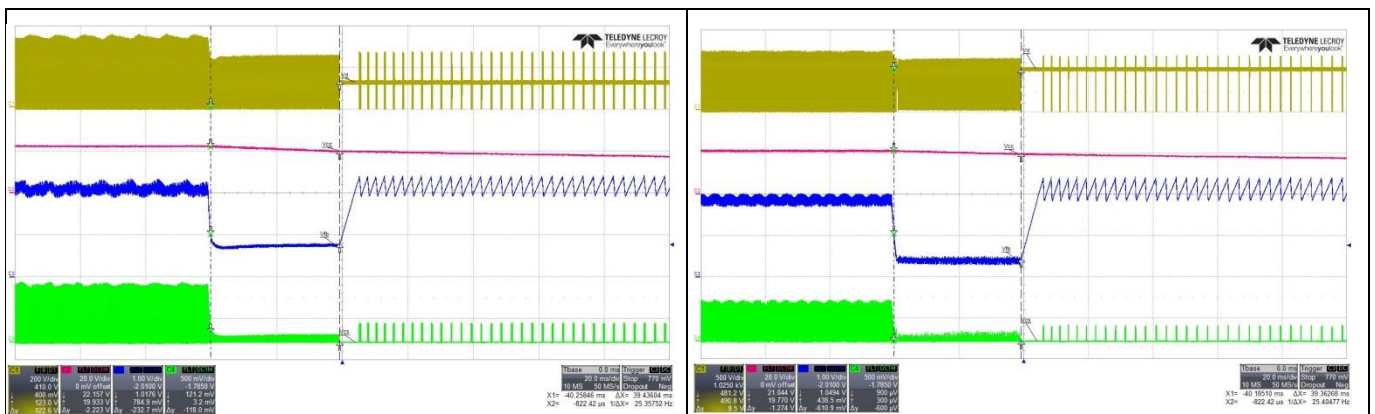

C1 (yellow) : Drain voltage (V_D)
 C2 (purple) : Supply voltage (V_{CC})
 C3 (blue) : FB voltage (V_{FB})
 C4 (green) : CS voltage (V_{CS})

C1 (yellow) : Drain voltage (V_D)
 C2 (purple) : Supply voltage (V_{CC})
 C3 (blue) : FB voltage (V_{FB})
 C4 (green) : CS voltage (V_{CS})

Condition to enter ABM level 1: $V_{FB} < 1.05$ V and $t_{blinking} = 36$ ms
 (load change from full load to 1 W load at 85 V AC)

Condition to enter ABM level 1: $V_{FB} < 1.05$ V and $t_{blinking} = 36$ ms
 (load change from full load to 1 W load at 300 V AC)

Figure 27 Entering ABM

Waveforms and scope plots

12.9 During ABM

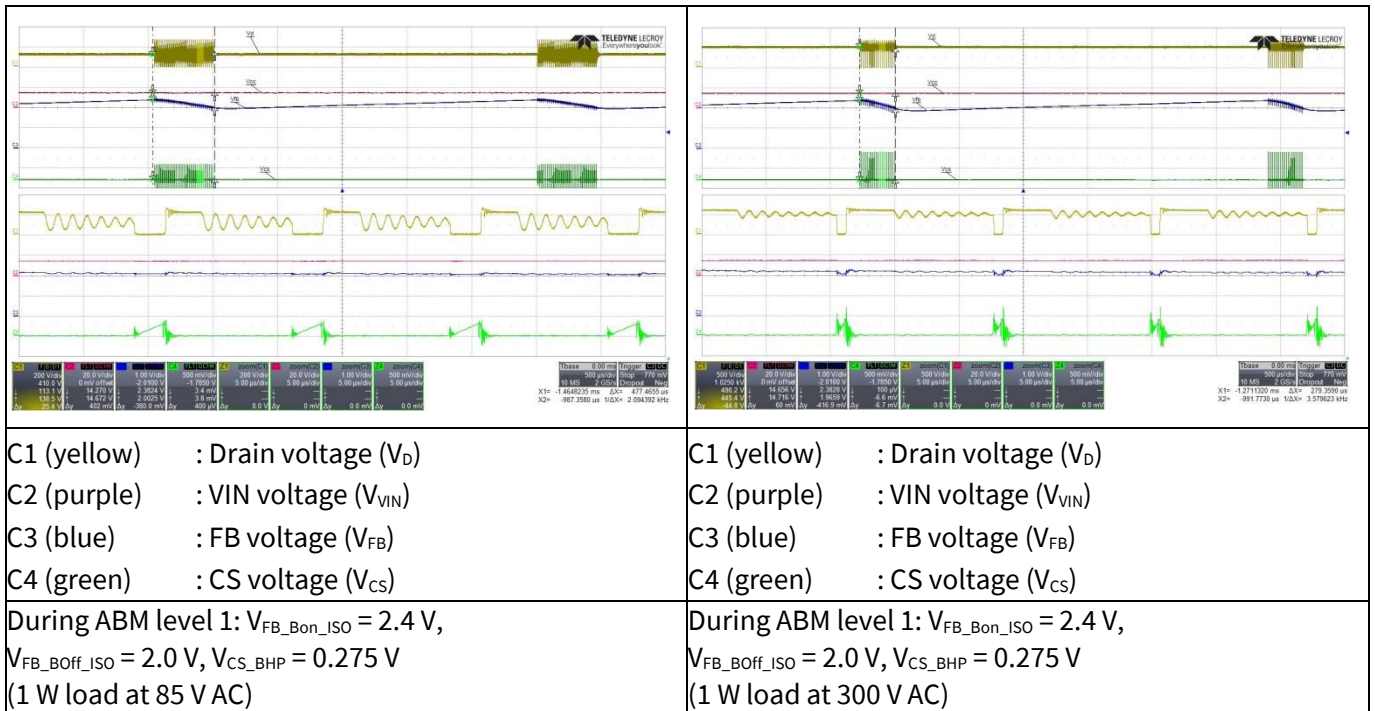

Figure 28 During ABM

12.10 Leaving ABM

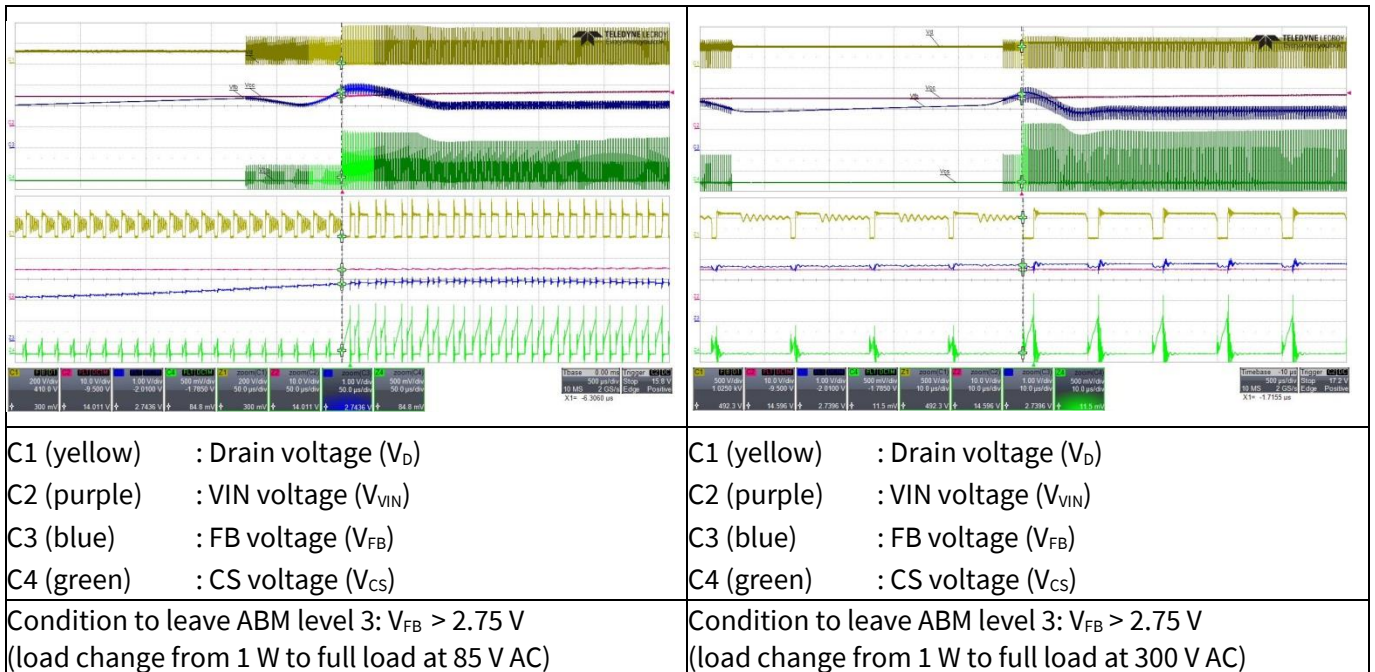
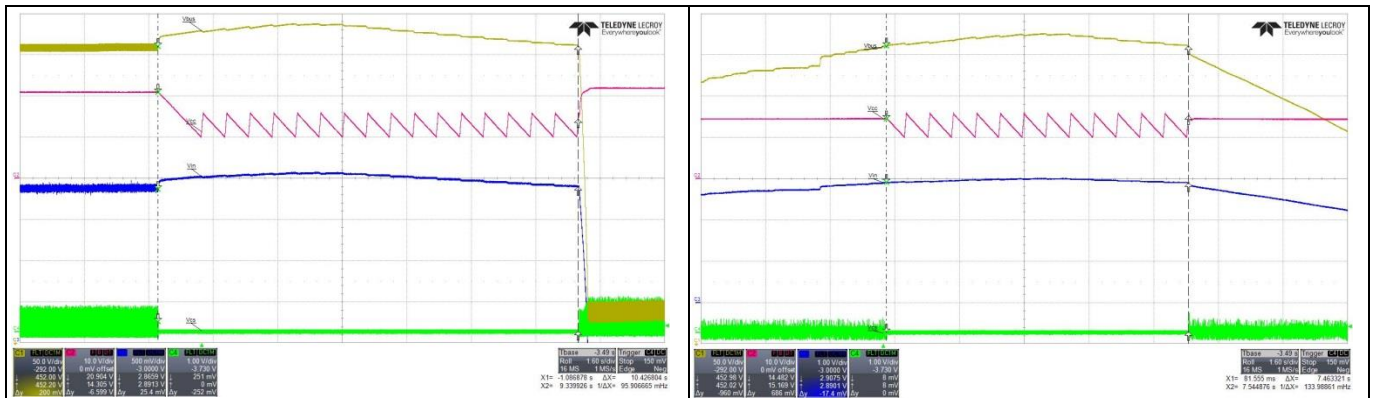

Figure 29 Leaving ABM

Waveforms and scope plots

12.11 LOV protection (non-switch auto restart)



C1 (Yellow)	: Bus voltage (V_{BUS})	C1 (Yellow)	: Bus voltage (V_{BUS})
C2 (Purple)	: Supply voltage (V_{VCC})	C2 (Purple)	: Supply voltage (V_{VCC})
C3 (Blue)	: VIN voltage (V_{VIN})	C3 (Blue)	: VIN voltage (V_{VIN})
C4 (Green)	: Current sense voltage (V_{CS})	C4 (Green)	: Current sense voltage (V_{CS})

Condition to detect Line over voltage protection : $V_{VIN} > 2.85\text{ V}$ ($V_{BULK} > 452\text{ V}_{DC} [\approx 320\text{ V}_{AC}]$)
 Condition to reset Line over voltage protection : $V_{VIN} < 2.85\text{ V}$ ($V_{BULK} < 452\text{ V}_{DC} [\approx 320\text{ V}_{AC}]$)
 (Gradually increase AC line voltage at full load till Line OVP detect and decrease AC line till Line OVP reset) (Gradually increase AC line voltage at 1 W load till Line OVP detect and decrease AC line till Line OVP reset)

Figure 30 Line over voltage protection at 320 V_{AC}

12.12 V_{CC} OVP (odd-skip auto restart)

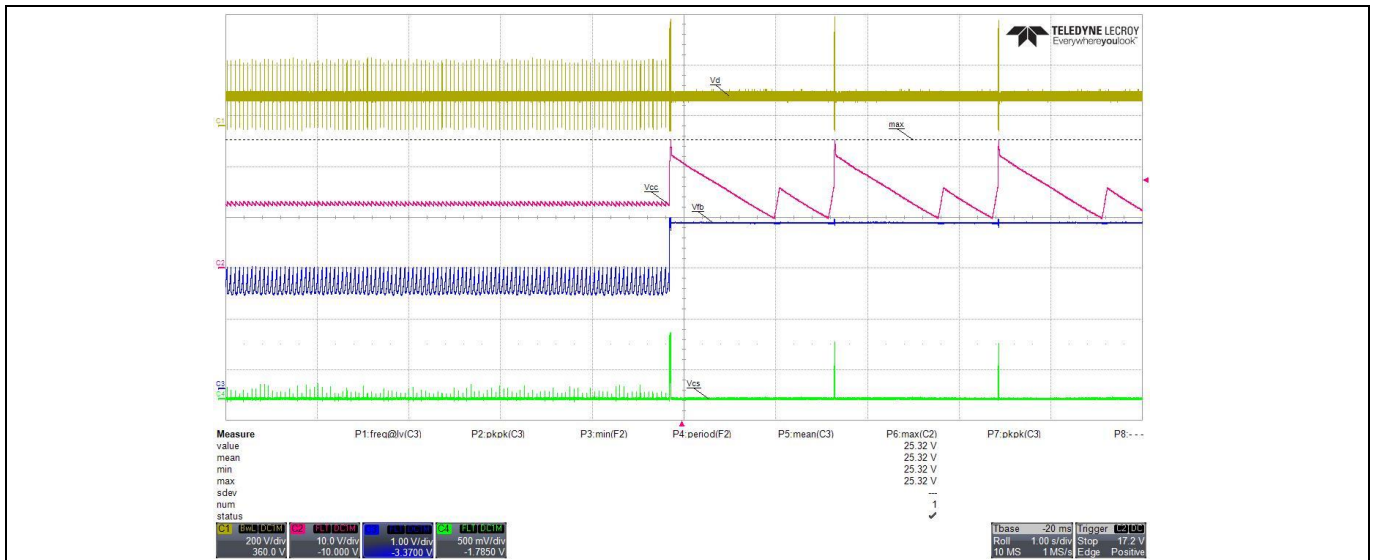

C1 (yellow)	: Drain voltage (V_D)
C2 (purple)	: Supply voltage (V_{VCC})
C3 (blue)	: FB voltage (V_{FB})
C4 (green)	: CS voltage (V_{CS})

Condition to enter V_{CC} OVP: $V_{VCC} > 25.5\text{ V}$
 (short R26 while system operating at 85 V AC and no load)

Figure 31 V_{CC} OVP

Waveforms and scope plots

12.13 V_{CC} UVP (auto restart)

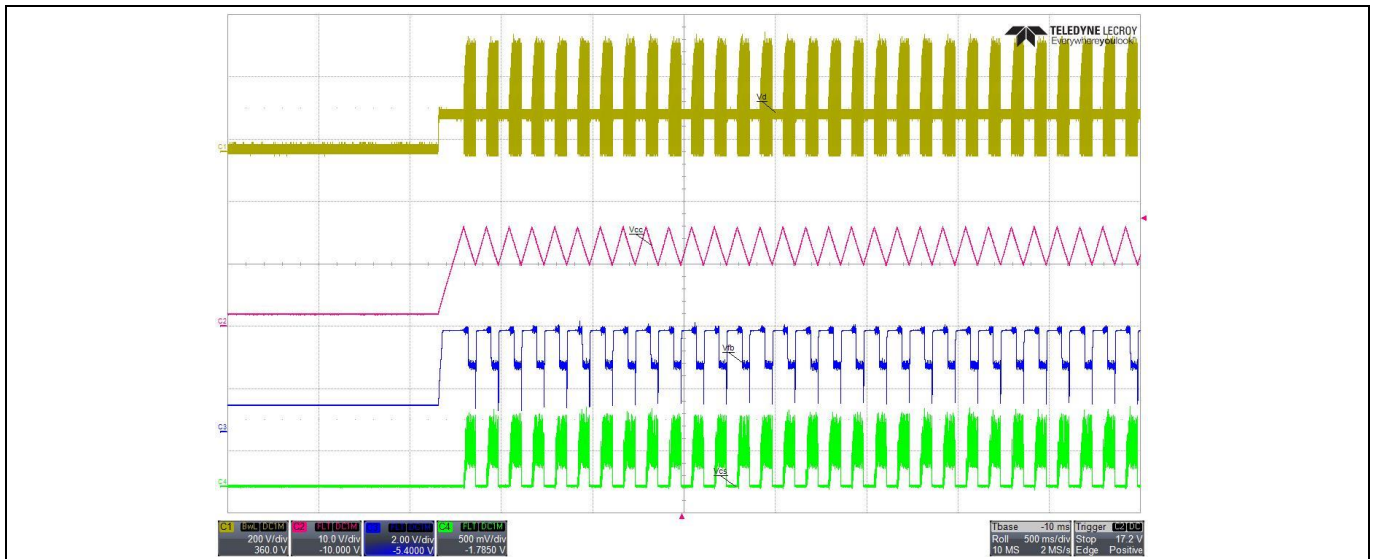

- C1 (yellow) : Drain voltage (V_D)
- C2 (purple) : Supply voltage (V_{VCC})
- C3 (blue) : FB voltage (V_{FB})
- C4 (green) : CS voltage (V_{CS})

Condition to enter VCC UVP: $V_{CC} < 10$ V

(Remove R12A and power-on the system with full load at 85 V AC)

Figure 32 V_{CC} UVP

12.14 Over-load protection (odd-skip auto restart)

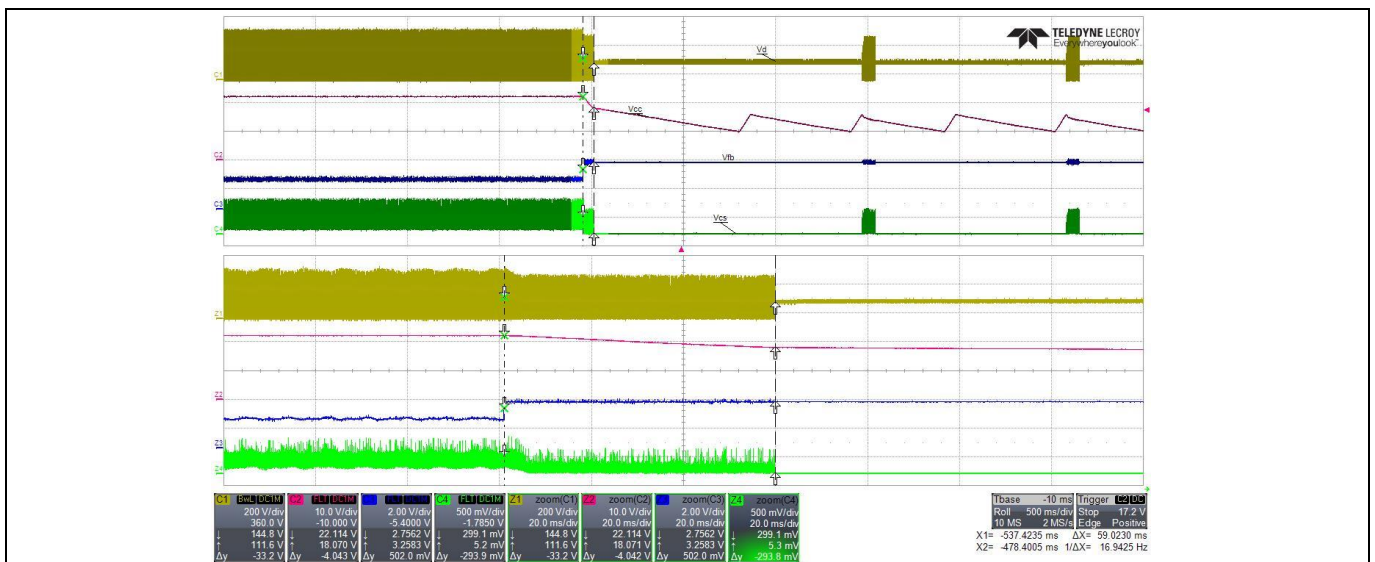

- C1 (yellow) : Drain voltage (V_D)
- C2 (purple) : Supply voltage (V_{VCC})
- C3 (blue) : FB voltage (V_{FB})
- C4 (green) : CS voltage (V_{CS})

Condition to enter over-load protection: $V_{FB} > 2.75$ V and last for 54 ms blanking time

(load change from full to short load at 85 V AC)

Figure 33 Over-load protection

12.15 V_{CC} short-to-GND protection

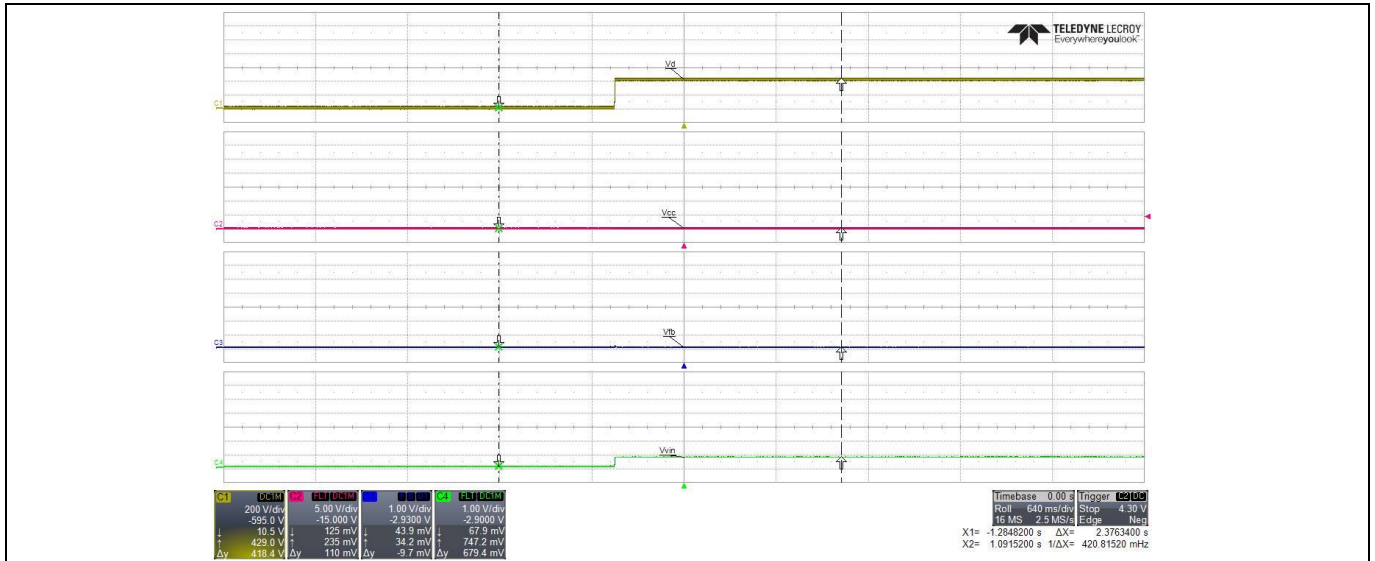

- C1 (yellow) : Drain voltage (V_D)
- C2 (purple) : V_{CC} voltage (V_{VCC})
- C3 (blue) : FB voltage (V_{FB})
- C4 (green) : V_{IN} voltage (V_{VIN})

Condition to enter V_{CC} short-to-GND: if $V_{CC} < V_{VCC_SCP} \rightarrow I_{VCC} = I_{VCC_charge1}$
 (Short VCC pin-to-GND and measure the current with multimeter before system start-up, I_{VCC} ≈ 600 μA and input power is ≈ 300 mW at 300 V AC)

Figure 34 V_{CC} short-to-GND protection

References

13 References

- [1] ICE5xRxxxxAG datasheet, Infineon Technologies AG
- [2] 5th Generation Fixed-Frequency Design Guide
- [3] Calculation Tool Fixed Frequency CoolSET™ Generation 5

Revision history

Revision history

Document version	Date of release	Description of changes
V1.0	2017-09-18	First release

Trademarks

All referenced product or service names and trademarks are the property of their respective owners.

Edition 2018-02-18

Published by

Infineon Technologies AG

81726 Munich, Germany

© 2018 Infineon Technologies AG.

All Rights Reserved.

Do you have a question about this document?

Email: erratum@infineon.com

Document reference

AN_201705_PL83_011

IMPORTANT NOTICE

The information contained in this application note is given as a hint for the implementation of the product only and shall in no event be regarded as a description or warranty of a certain functionality, condition or quality of the product. Before implementation of the product, the recipient of this application note must verify any function and other technical information given herein in the real application. Infineon Technologies hereby disclaims any and all warranties and liabilities of any kind (including without limitation warranties of non-infringement of intellectual property rights of any third party) with respect to any and all information given in this application note.

The data contained in this document is exclusively intended for technically trained staff. It is the responsibility of customer's technical departments to evaluate the suitability of the product for the intended application and the completeness of the product information given in this document with respect to such application.

For further information on the product, technology, delivery terms and conditions and prices please contact your nearest Infineon Technologies office (www.infineon.com).

WARNINGS

Due to technical requirements products may contain dangerous substances. For information on the types in question please contact your nearest Infineon Technologies office.

Except as otherwise explicitly approved by Infineon Technologies in a written document signed by authorized representatives of Infineon Technologies, Infineon Technologies' products may not be used in any applications where a failure of the product or any consequences of the use thereof can reasonably be expected to result in personal injury.